

# GRAY DEATH LEGION



®  
BATTLETIEVE



# GRAY DEATH LEGION

# THE SAGA OF THE GRAY DEATH LEGION



**Design and Writing**  
William H. Keith, Jr.

**Editorial Staff**  
*Editor-In-Chief*  
L. Ross Babcock III  
*Senior Editor*  
Donna Ippolito  
*Editor*  
Todd Huettel

**Production Staff**  
*Interior Design*  
Jordan Weisman  
*Cover Art*  
Jim Holloway  
*Illustration*  
Dana Knutson  
Todd F. Marsh  
Jeff Laubenstein  
*Typesetting and Layout*  
Tara Gallagher  
*Pasteup*  
Dana Knutson  
Todd F. Marsh  
Jeff Laubenstein

**BATTLETECH, CITYTECH, AEROTECH, MECHWARRIOR, 'Mech and BattleMech**  
are trademarks of FASA Corporation registered in the U.S. Patent and Trademark offices.  
Copyright © 1986 FASA Corporation.  
All Rights Reserved. Printed in the United States of America.

Published by  
FASA Corporation  
P.O. Box 6930  
Chicago, IL 60680

# TABLE OF CONTENTS

INTRODUCTION	5
THE GRAY DEATH LEGION	6
<b>Brief History</b>	6
Trellwan	6
Verthandi	6
Among The Free Worlds	7
Betrayal	7
Against House Kurita	7
<b>Grayson Death Carlyle</b>	8
<b>Brief Regimental History</b>	9
Regimental Banner	9
Formation	9
Gray Death Mercenary Company	9
Gray Death Regiment	9
THE GRAY DEATH LEGION	
<b>Command Lance</b>	10
Grayson Death Carlyle	10
Lori Kalmar	11
Sergeant Delmar Clay	12
Davis McCall	13
<b>Fire Lance</b>	14
Lieutenant Hassan Ali Khaled	14
Isoru Koga	15
Charles Bear	16
Sharyl	17
<b>Recon Lance</b>	18
Lieutenant Gomez de Villar	18
Tracy Kent	19
Randolph Blake	20
Erin Sharpeley	21
ALONE ON TRELLWAN	22
DECISION AT THUNDER RIFT	24
BLOCKADE RUNNER	26
FIRST MISSION	28
NAGUMO'S TRAP	30
THIRST FOR VENGEANCE	32
BETRAYAL AT HELM	35
Scenario 1	36
Scenario 2	38
Scenario 3	40
Scenario 4	42
RUN FOR YOUR LIFE	44
BREAKOUT AT KO	46
RIPOSTE	48
MEET THE CRIMSON BLADE	50
OF BLOOD AND HONOR	52
NIGHT STRIKE	54

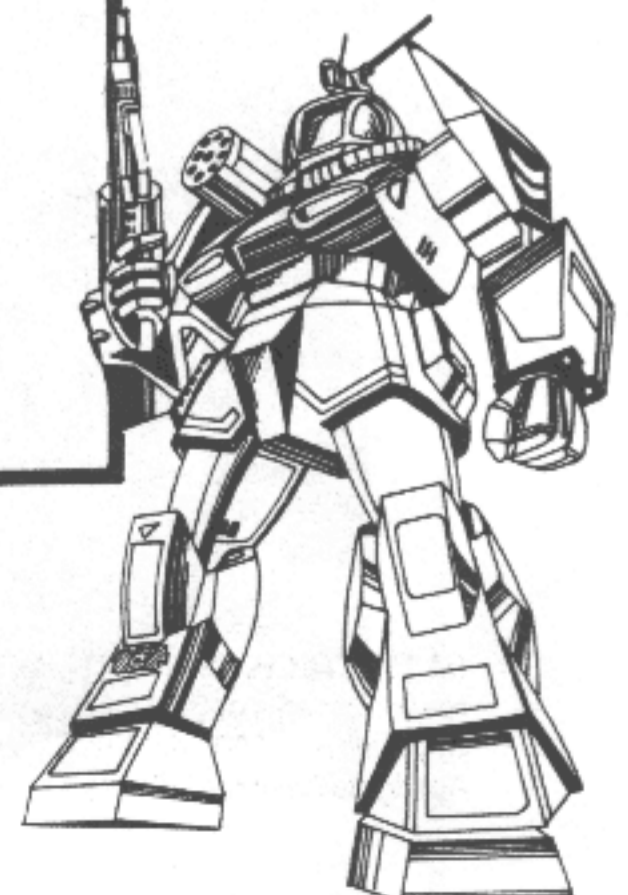
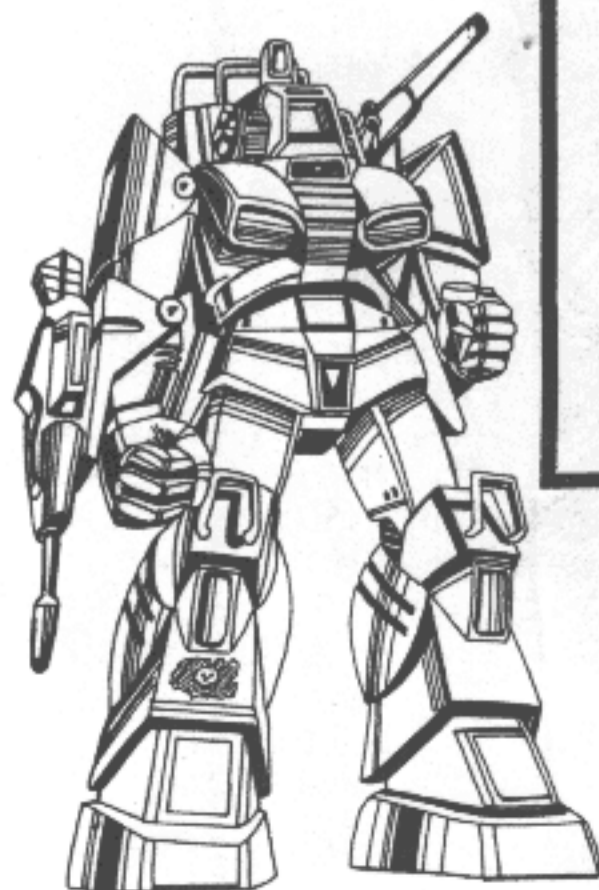
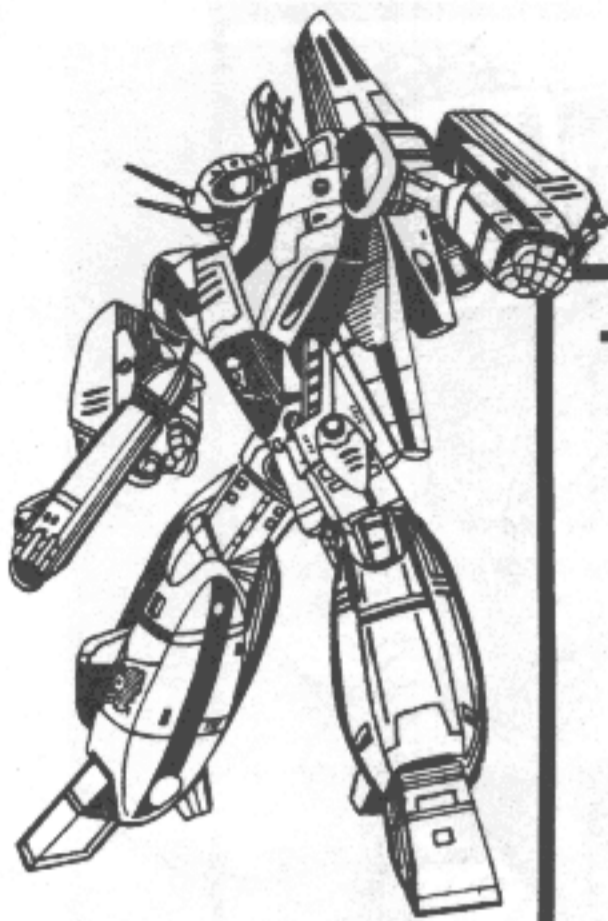



# INTRODUCTION

Excerpted from *Fire and Blood: A Concise History of the Succession Wars*, by Huang Shi Ramachandra, Avalon Press, 3032

It is said that the Gray Death Legion, one of the most feared mercenary units in known space, had its beginnings in one man's search for vengeance. It is also said that the unit just plain hates House Kurita so much that they sign on with one employer or another more for the fun of crunching Combine skulls than for mere financial gain. But how much can anyone fathom a mercenary's thoughts or motives, ambitions or secret feelings? By a tradition far older than space flight, comrades-in-arms share a special bond without words, an understanding denied those who have not tasted combat together.

**The Gray Death Legion** provides an overview of Grayson Death Carlyle, his MechWarriors, and the Gray Death Legion, the mercenary unit he made famous. It allows real-time simulations of the combat situations that Carlyle and his people faced—perhaps the best way to get inside a MechWarrior's skin and to begin to understand what he does.

It is the story of an extraordinary group of men and women, and the vendetta they waged across the worlds of a hundred suns. It is also the story of a bitter war of vengeance.

## HOW TO USE THE SCENARIOS

Each of the scenarios in this book recreates battles or encounters in which Carlyle's Gray Death Legion took part. Several of the scenarios are interrelated, representing various phases of a single, continuous battle or campaign. If desired, players may keep track of battle damage taken by the various 'Mechs from one engagement to another, with the damage and losses suffered earlier in the campaign affecting the condition and make-up of the forces engaged at the end. The **Special Rules** for each scenario describe what repairs, if any, are possible between engagements.

The scenario rules include all information necessary to understand the game situation and play it out. Each scenario begins with a firsthand account by one of the warriors who participated in the actual engagement, followed by a brief historical sketch of the battle.

The **Game Set-Up** sections provide whatever special game information is needed to play the scenarios, including instructions on how to lay out the mapsheets, directions for special terrain features encountered, and suggestions on the appropriate **BattleTech** rules to use. In some cases, there are also suggestions for using FASA's **CityTech** and/or **AeroTech** rules to make play more exciting or challenging. (A number of scenarios require both **CityTech** and **BattleTech** maps. When using the maps together, players can simply lay them out side by side.)

Attacker and Defender forces for each scenario are described in detail. This information includes damage, problems, or special abilities of any 'Mechs or forces at the start of the battle. Also noted is each 'Mech's starting position on the map, or where and when it enters if the 'Mech arrives after the battle has already begun.

Several scenarios include ground forces for one or both sides. The rules generally allow the player to choose his own mix of vehicles and/or troops up to a certain, stated number of tons. See **CityTech** for the rules for creating and using both vehicles and troops.

The **Victory Conditions** are described next. These determine the outcome of the encounter, and vary from scenario to scenario. It is very rare in actual combat that an action continues to the point where one side or the other is completely obliterated. For this reason, the **Victory Conditions** usually list special objectives for one or both opponents. As in actual combat, both sides may claim victory in some engagements, based solely on whether or not tactical objectives were won.

Finally, if the scenario requires rules not covered in the general **BattleTech** rules, they are discussed as Special Rules. Tips on winning the battle are sometimes included here as well.

The Modified Skill Roll Targets provided for the 'Mech *Gunnery* and 'Mech *Piloting* skills for each member of the Gray Death Legion are the base targets for any combat rolls. These can be further modified by range, terrain, and action, depending on the combat situation. The full range of MechWarrior skills can be used to help determine the outcome of any encounter involving Grayson Carlyle and his Companions.

All other 'Mechs have regular **BattleTech** *Gunnery* and *Piloting* skills and should be used normally. If specific skill levels are not given, assume a *Piloting* skill level of 5 and a *Gunnery* skill level of 4.

## BRIEF HISTORY

### TRELLWAN

The Gray Death Legion was born on Trell I, a desert planet far from the Inner Sphere of human-inhabited worlds. Known as Trellwan by its inhabitants, the planet occupied a marginally strategic location on the periphery of Lyran Commonwealth space. Nearby, within a few score light years, were worlds claimed by the Draconis Combine. Farther out was the fledgling empire of Bandit King Hendrik III. Trellwan was garrisoned by a single lance of Steiner regulars commanded by Captain Durant Carlyle.

Though a remote world, Trellwan's location gave it tremendous potential in the vicious, inter-House intrigue of the Succession Wars. It was here that Steiner agents laid the foundations for an alliance with Hendrik III of Oberon, the mercurial Bandit King who had previously been negotiating openly with agents of House Kurita. Hendrik's deal with Steiner gave him garrison and tax-collection privileges on Trell I in exchange for his fealty to Katrina Steiner and the Commonwealth. This would have freed up Captain Carlyle's lance for duty elsewhere in the Inner Sphere, where experienced 'Mech pilots were sorely needed.

When he learned of House Steiner's negotiations with Hendrik, Duke Hassid Alexander Ricol, the notorious Red Duke of the Draconis Combine, evolved his own devious counterplan. He would seize Trellwan from the Commonwealth, but convince the planet's defenders that Hendrik III was their attacker. Then, to 'save' the Trells from Hendrik's raiders, the Duke would send in a second assault force. By the time the Steiner forces returned—if they returned—Duke Ricol would be firmly in control, and the planet's inhabitants would be loyal to him, their savior. Trellwan would become a dagger in the Commonwealth's back, a staging area for launching attacks toward Drune II, Sylven, and, ultimately, toward the Steiner capital, Tharkad itself.

Through his agents within the confederation of Bandit Kings ruled by Hendrik, the Red Duke managed to hire mercenaries from Hendrik's own forces.

These 'Mech pilots participated in a sneak attack against Durant Carlyle's garrison on Trellwan. With the help of a Trell traitor, the Red Duke's assault troops secretly landed an unarmed DropShip freighter at the spaceport, then penetrated the garrison command base. Carlyle himself was killed in the attack, and the base was captured. The garrison's survivors managed an orderly withdrawal to their DropShip at the port and then escaped offworld, leaving behind their 'Mechs and most of their equipment.

One member of Carlyle's Commandos did not escape. Grayson Death Carlyle—his grim middle name the legacy of an ancestor, the Victor of Lysander—was the only son of Durant Carlyle. Though not yet a fully-rated 'Mech pilot, he had already been in training half his life for the day he would inherit his father's *Shadow Hawk* and the command of Carlyle's Commandos. Grayson showed great promise, but his instructors frequently complained about his lack of discipline.

Though he survived the attack on the base, Grayson Carlyle was marooned on Trellwan, with no way of getting offworld. He managed to attract the attention of Trellwan's rulers by using his special knowledge of BattleMech tactics to organize the rather ineffectual local troops in a successful defense of the heart of Trellwan's capital. By capturing several bandit 'Mechs—one by the rather startling expedient of facing it down, unarmored, with a man-portable inferno launcher—he created the nucleus of Trellwan's own BattleMech unit, the Trellwan Lancers.

Though continuously outnumbered and beset by infighting and treachery within the Trell bureaucracy and military commands, Carlyle managed to bloody the enemy force on the planet, and to discover that the enemy was, in fact, not Hendrik of Oberon, but the Draconis Combine. In the climactic Battle of Thunder Rift, Carlyle's men battered the Red Duke's forces so severely that Duke Ricol chose to withdraw from Trellwan now that his presence on the planet was no longer a secret. Fortunately for Carlyle, the Duke remained unaware that the Lancers' strength had been reduced in the fight to one relatively intact 'Mech and 30 unwounded troops.

Carlyle decided to depart as well. He now had a ship, an aging freighter manned by Free Worlds traders who had fought with him. Soured on Trellwan because of the political intrigue raging in its capital, Grayson also had hopes of tracking down the survivors of the old Carlyle's Commandos. The Lancers, refitted, reorganized, and now named the Gray Death, left Trellwan to seek employment as BattleMech mercenaries among the strife-ravaged worlds of the Inner Sphere.

### VERTHANDI

Carlyle's first move was to bolster his tiny force, which numbered five 'Mechs, two MechWarriors, and barely 150 troops. At Galatea, he recruited experienced 'Mech pilots to man the unit's vacant machines, and expanded the Legion to eight 'Mechs organized into Fire and Command Lances. Their first employer was Devic Erudin, leader of a precarious rebellion on a world called Verthandi.

It was a desperate undertaking; the rebellion had scant chance of success. However, an untried, eight-'Mech mercenary company had an equally scant chance of employment. Besides, Verthandi was across the border in Kurita space, and was, in fact, part of Ricol's duchy. For Grayson Carlyle, the chance to strike back at his father's murderers was too good to pass up.

They almost did not reach the planet. Ricol's forces had it blockaded, and its AeroSpace Fighters managed to intercept the Legion's DropShip on its approach. Once down, they found themselves in the middle of a vicious and unrelenting war that masked a policy of cold and calculated genocide.

At Verthandi, the Gray Death Legion learned a priceless lesson that many a freedom fighter has: Even the largest military giant can be brought low—or at least driven off—if his attacks can be made expensive enough. After a long campaign, the forces of the Free Verthandian Republic emerged victorious, and the Gray Death returned to the Galatean mercenary marketplace with three full lances and enough tanks, armored vehicles, and recon craft captured on Verthandi to make the Legion a creditable force. Their reputation preceded them. Almost immediately, a representative from Duke Marik and the Free Worlds League signed the Gray Death to its service.

## AMONG THE FREE WORLDS

The Free Worlds League of House Marik lies between the Lyran Commonwealth of House Steiner and the Capellan Confederation of House Liao. At the time the Gray Death was in his employ, Marik was seeking to create a special strike force for a series of hit-and-run raids aimed at keeping the Liao forces off balance. For a period of over one standard year, the Gray Death Legion operated along the Capellan border, striking deep into Liao space at communications centers, fleet depots, Mech assembly plants, mines, and industrial worlds. They suffered heavy losses, but the name of the Gray Death Legion was by now well known, a magnet attracting MechWarriors and loose mercenaries with the promise of glory, of action, and of loot.

Unfortunately, the arrangement could not last. As part of his contract with Marik, Carlyle's unit was to have use of a planet named Helm as its home base between campaigns. As it turned out, intrigue, corruption, and revolt within the Marik high command led first to an attempt to destroy the Legion in combat against Liao, then to a Free Worlds attack on the new home base on Helm. Barely escaping in one piece, the Gray Death Legion fled.

## BETRAYAL

It was a military faction working against the government of Janos Marik within the Free Worlds League that sought to discredit the Gray Death Legion in order to seize Helm, his promised base and Landhold. The faction carried out the plot first by accusing the Legion of atrocities in battle, and then by seizing Helm "while the matter was investigated". Second-line troops, trainees, and even the support personnel at the Helm base resisted the invasion with ferocity born of desperation. Though Carlyle returned too late to prevent the sack of Helm, he arrived ready for combat and caught the Marik renegades on the ground and unprepared. The battle and subsequent pursuit provided one of the few instances in modern warfare where one side was hunted down and exterminated to the last machine.

The reason behind the Marik faction's betrayal was discovered during the campaign: a forgotten storehouse of old Star League Mechs and equipment on Helm. The Legion fought a holding action against elements of Marik's 4th and 7th Light Assault Groups and the 12th White Saber Legion while the colony survivors and the uncovered treasure were loaded aboard ship and evacuated offworld.

## AGAINST HOUSE KURITA

There were others who could use the Gray Death's talents and experience. Refitted again at Galatea, they were hired by a faction within the Lyran Commonwealth to organize a series of raids against the Draconis Combine. Experience gained in service to Liao now stood the Legion in good stead. The unit was largely responsible for the successes of House Steiner's Orestian Campaign, conducting search-and-strike missions deep inside Kurita space, creating diversions, raiding supply dumps and staging areas, and forcing Kurita's generals to redeploy and expose themselves to Hanley's fleet at Orestes. The Legion's battle honors included the savage fights at Caldrea and Otho, and the rear-guard delaying action at Trolloc Prime.

At Baldur, the Gray Death Legion landed secretly in advance of the main offensive. In a series of unconventional, lightning strikes, Carlyle succeeded in blowing up a critical fusion power plant and blacking out planetary defense radars across Baldur's ice-capped southern hemisphere. Once Hansen's Roughriders and several regular Steiner companies had formed a beachhead, Carlyle's continued attacks distracted Kurita's commanders long enough to

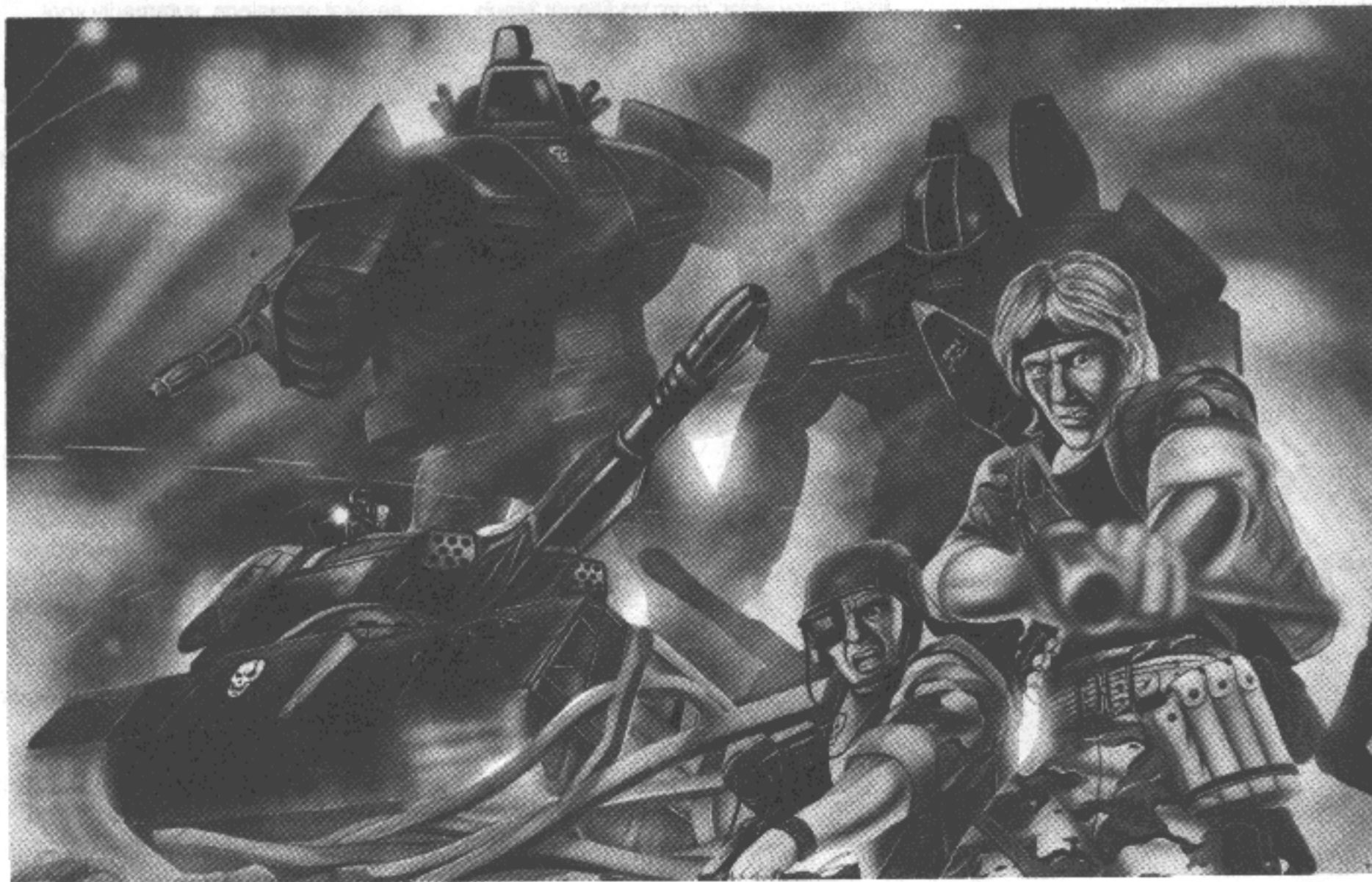



enable the 1st Lyran Guards to make their breakout at Ko, and to complete the encirclement of the Baldur port garrison.

By 3030, the Commonwealth's advance had been slowed, as forces on both sides became bogged down in a dead-end slugfest that engulfed a dozen systems. The Gray Death continued in active service, however, enabling Steiner's forces to disengage on Lothan, disrupting an enemy invasion fleet at Nox, and capturing a vast store of 'Mechs, supplies, and equipment on Darius. By this time, the Gray Death had expanded to regimental size, and included elements of a number of former disbanded or battle-broken units, including remnants of the old Carlyle's Commandos.

What was perhaps most unusual about the Legion was the moral quality of their fight. What began as a desire for revenge against House Kurita became a virtual crusade against the technological barbarism and inhumanity that Kurita's campaigns and the Succession Wars themselves had come to represent. MechWarrior Grayson Death Carlyle became known as one of a handful of men and women who fought to hold the dark tides of savagery at bay for yet a little while longer.

That is a distinction won by very few warriors in man's bloody history.

## GRAYSON DEATH CARLYLE

### Brief Personal History:

As of early 3030:

*Colonel, Gray Death Legion*

*Awarded the Order of the Crimson Star, with cluster*

*Awarded the Order of Atreus*

*Awarded the Lyran Harp*

*Awarded the Verthandian Sunburst*

*Awarded the Emerald Star*

Though records of the Successor States are fragmentary at best, it is believed that Grayson Death Carlyle is one of the youngest regimental leaders serving in combat. Certainly, his first campaigns were waged while he was barely out of his teens, and he was commanding a full, company-strength, independent mercenary unit by the time he was 22 standard years old.

Carlyle seems to be one of those rare individuals who is a born military tactician. He learns the weaknesses and strengths of his opponents, both unit commanders and the individual MechWarriors his own unit must confront, and stresses close cooperation among his own men in combat. More than many older, more traditional 'Mech unit commanders, he has developed the cooperation between his 'Mechs and conventional ground and air units to a precise science. Many of his most brilliant victories made use of conventional armor, hovercraft, or AWCs

mounting missile launchers or beam weapons, of troops carrying man-portable anti-armor weapons, and even of traps and concealed pits cunningly dug into the battlefield in the path of an enemy's advance. It is widely agreed among armchair strategists throughout the Successor States that Carlyle, if he lives, could become known as one of the greatest military leaders of all time.

Carlyle himself seems convinced that he will *not* live, an attitude based less on numerous close brushes with death than a pessimistic assessment of the future of human civilization. "We're living at the raw, ragged edge of the Dark," Carlyle has been quoted as saying. "The Dark is a vast and voracious monster rising up to swallow us and everything we have built or thought or striven for in the last ten thousand years. A handful of us prod that monster with sticks to keep it at bay...not a very healthy situation at all." He is careful, of course, not to allow this pessimism to infect his command.

Carlyle is a strict disciplinarian with his troops, but is known both for his fairness and for his willingness to share the risks. He is also known for the moral stance he enforces both on and off the battlefield. For example, he has, on several occasions, summarily shot rapists or murderers in his own command. On Verthandi, he went to extraordinary lengths to trap and wipe out a Kurita Merc company that had exterminated whole villages and sold the survivors into slavery.

With the passing years and after many battles, Carlyle's reputation has made his a highly sought-after unit. However, he has spurned numerous offers of employment in a most unmercenary fashion when it was agents of House Kurita or House Liao offering him contracts. Since the betrayal of the Gray Death by a faction of House Marik, he has also refused offers of work from the Free Worlds League, and seems content working solely for the Lyran Commonwealth or House Davion's Federated Suns. It is rumored that his stubbornness on this point has led to serious trouble within the ranks of the Gray Death, to the point of attempted mutinies on at least two separate occasions.

It is entirely possible that Carlyle is correct in his assessment of his own future and the future of Mankind.

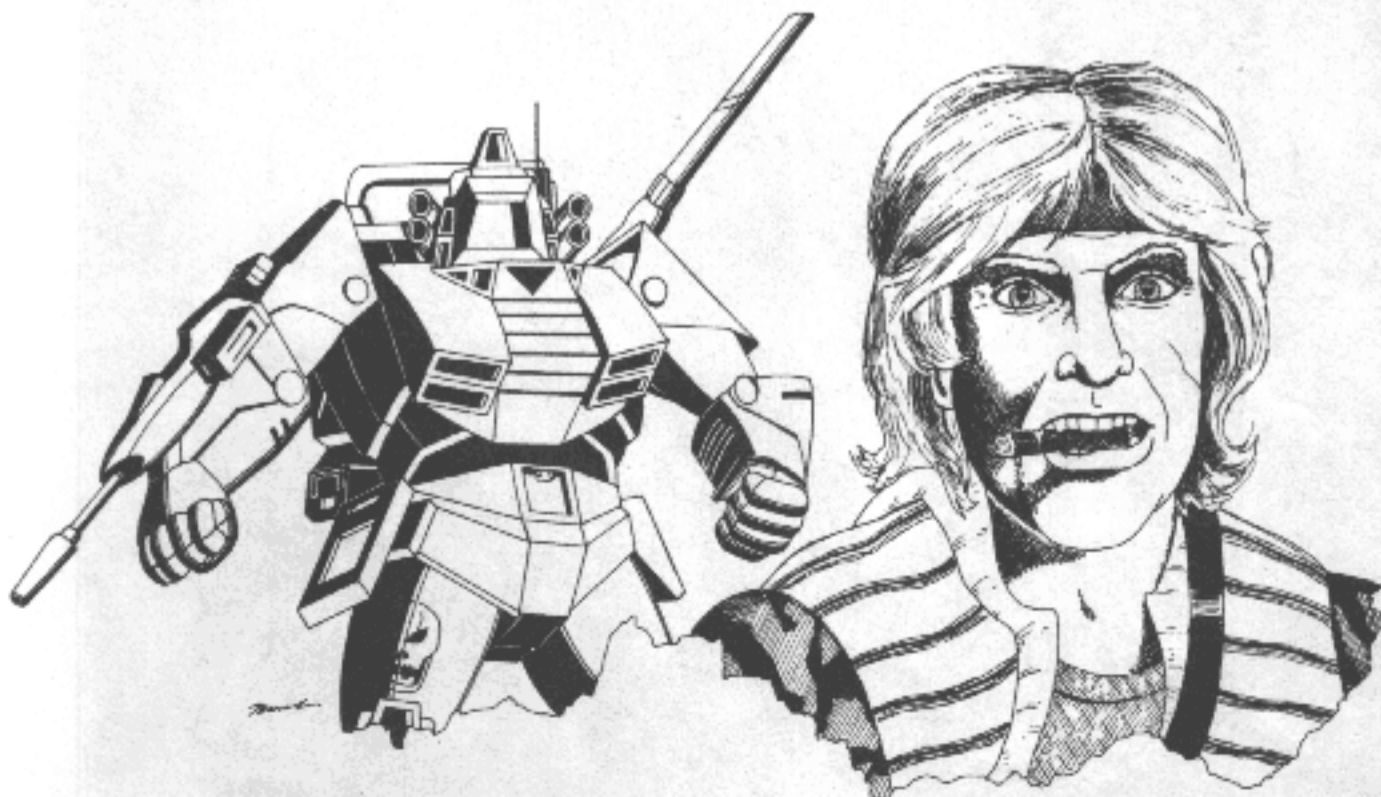

## BRIEF REGIMENTAL HISTORY

### THE REGIMENTAL BANNER

The unit banner is a black-outlined gray skull against a scarlet background. It is generally displayed on the left leg of the unit's 'Mechs, and as a unit badge worn on uniforms of the troops and ground support personnel.

### FORMATION

Carlyle's headquarters unit began as the five 'Mechs taken by the Gray Death Legion from Trelle after the campaign there against Duke Ricol. At Verthandi, the unit captured and refitted enough enemy 'Mechs to allow the formation of two full lances. The Command Lance became known as Carlyle's Companions, and later as the Gray Death Companions, while the Fire Lance was tagged as Hassan's Assassins. Much later, a Recon Lance was added, consisting of the remnants of the old Carlyle's Commandos. For obvious reasons, the former unit name was retained.

Only two 'Mech pilots survived the fires of the unit's birth on Trelle I. These were Grayson himself and Lori Kalmar, a former pilot-trainee from one of Hendrik of Oberon's planetary militias. The unit recruited three additional pilots at Galatea, and the rest elsewhere at various times. The Companions were officially so designated toward the conclusion of the Verthandian Campaign, when the Gray Death could muster two full lances.

### THE GRAY DEATH MERCENARY COMPANY

By the time of the offensive against House Liao in 3026 (Terran Calendar), the Gray Death could muster an entire company of three lances, organized as Command, Fire, and Recon Lances, plus an attached Air Lance. The unit suffered heavy losses during the evacuation of Helm, but was filled out again during their return to Galatea in the Lyran Commonwealth.

### THE GRAY DEATH REGIMENT

Carlyle's fame and the reputation of his unit attracted adventurers and MechWarriors from all over the Inner Sphere. Recruitment and training proceeded swiftly on Galatea, and later on the new homeworld granted them by Katrina Steiner. Carlyle's Gray Death Legion was designated a short mercenary regiment of five companies and two air lances when House Steiner formally contracted with the unit at the onset of the Orestian Campaign in 3029. The lead company was named the Gray Death Companions, and was organized around a nucleus of the original members of the old independent company.

The regiment suffered heavy casualties during the vicious fighting in the Orestes Cluster, where the battles at Baldur, Otho, and Trolloc Prime all took their toll. Nevertheless, the skilled leadership and expert tactics of Grayson Carlyle—now a full colonel—was creating a legend being recounted from the Periphery to the Commonwealth to the halls of New Avalon. These stories were invariably tales of glory. Only the members of the Gray Death Legion would remember how those tales had first been written in blood.



# COMMAND LANCE

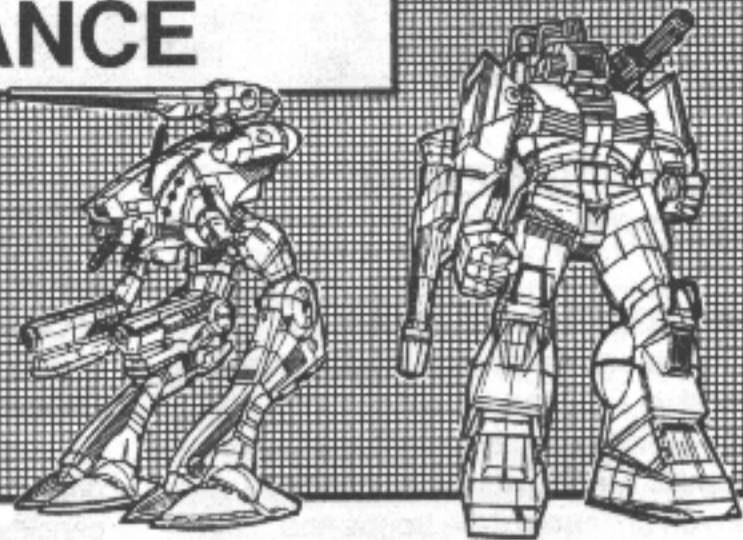

company-strength Lyran Commonwealth regular unit on independent detached duty. A sneak attack by Kurita's Red Duke destroyed the Commandos' garrison lance on the planet Trell I and killed Durant Carlyle. Grayson was forced into hiding, from which he emerged to build his own mercenary combat unit.

Carlyle is acknowledged by friends and foes alike as a brilliant tactician and superb organizer. Troops and MechWarriors who have campaigned with him since the unit's earliest days are devoted, vowing they would follow him into hell if he gave the word. At the same time, Carlyle is torn by self-doubt, which he hides in a murderous drive for vengeance against the powers that killed his father. He is certainly among the youngest combat 'Mech unit commanders in the Successor States. Since his father's death, the Gray Death Legion has been Carlyle's only family, and he shares an especially close relationship with one of his pilots, Lori Kalmar.

Carlyle's organizational genius is evidenced by the quality of the mercenary unit that he has built from scratch and raised to a crack professional team in a space of less than eight years. His tactical ability is confirmed by his record, which is rapidly becoming the stuff of legend throughout the Successor States.

**Pilot:** Colonel Grayson Death Carlyle, "The Gray Death"

**BattleMech:**

At Trell I and Verthandi: SHD-2H *Shadow Hawk*  
After Verthandi: MAD-3R *Marauder*

**Skills:**

At Verthandi:	<i>Piloting Skill level</i>	2
	<i>Gunnery Skill level</i>	1
Against Liao:	<i>Piloting Skill level</i>	3
	<i>Gunnery Skill level</i>	2
Against House Marik:	<i>Piloting Skill level</i>	4
	<i>Gunnery Skill level</i>	3
During Orestian Campaign:	<i>Piloting Skill level</i>	5
	<i>Gunnery Skill level</i>	4

**BattleMech Status Report:**

Until Verthandi, Carlyle piloted a SHD-2H *Shadow Hawk* that had formerly belonged to his father's unit, Carlyle's Commandos. The 'Mech was in perfect condition, until it was badly mauled during the Verthandian Revolt.

During the Verthandian campaign, a captured MAD-3R *Marauder* became Carlyle's command machine. During the Liao campaign, Carlyle added extra armor to protect the rotation ring between the chassis and leg assembly, and at the vulnerable linkage for the dorsal autocannon.

**MechWarrior Data:**

Grayson Death Carlyle is tall, slightly built, and wiry, with blond hair and pale grey eyes. Much of his early life was spent in training for the day when his father would retire and the son would take his place as commander of Carlyle's Commandos, a

**Name:** Grayson Carlyle

**Age:** 26

**Rank:** Colonel

**Affiliation:** Mercenary

**Home Planet:** Calaeras

**Mech Type:** Marauder

**Warrior Data:**

BODY - 9	CHA - 10
DEX - 10	PIB - 10
LRN - 12	HTK - 90

Total XP: 135,000

XP Available: 20,000

Skills	Skill Level	Attribute Target	Modified Skill Roll Target
Athletics	2	8	6
Acrobatics	2	8	6
Climbing	2	8	6
Swimming	2	8	6
Computer	5	6	1
Diplomacy	3	7	4
Driver	3	7	4
Gunnery/Mech	4	7	3
Leadership	5	7	2
Piloting/Mech	5	7	2
Pistol	4	7	3
Rifle	5	7	2
Survival	2	8	6
Tactics	6	6	0
Technician	4	6	2

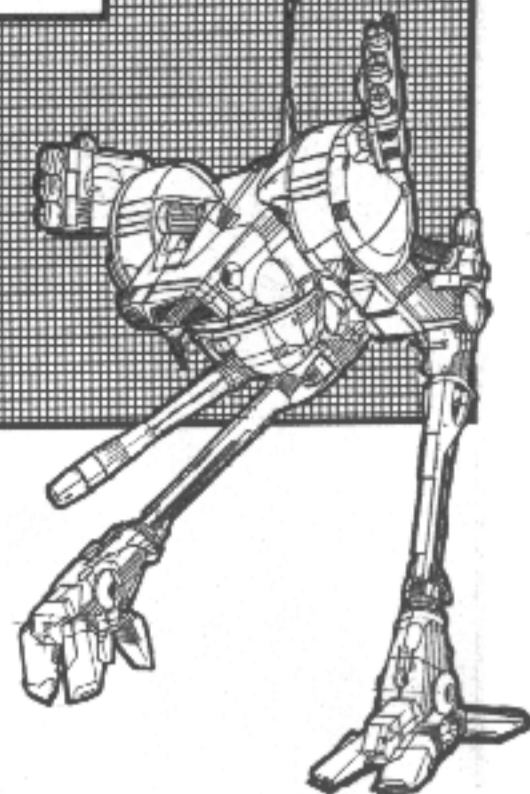
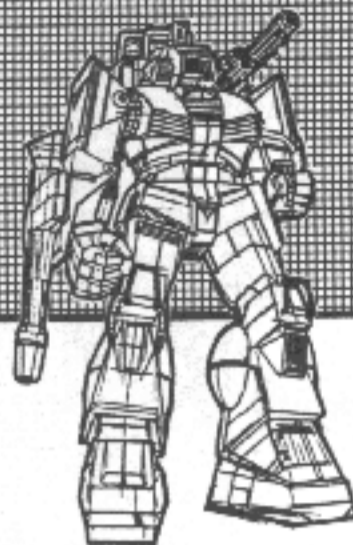

apprentice, she and several other junior 'Mech pilots were assigned to a task force commanded by Duke Ricol of the Draconis Combine as part of a secret deal cut with a minor warlord under Hendrik III. She was captured on Trell by Grayson Carlyle, but later switched sides to serve with him first as a Tech, and later as a full-fledged MechWarrior.

Kalmar has one significant weakness in combat. As the survivor of a fire that destroyed her home and killed her parents when she was a child, she is terrified of death by fire. Tormented on this account by her own self-doubts, Lori shares a close, if occasionally stormy, relationship with Grayson Carlyle, who has helped her face her fears.

Despite this weakness, Lori Kalmar is a skillful and resourceful warrior. Carlyle recognized these qualities when he commissioned her in the field. For a time, she commanded the Gray Death's Fire Lance. At her own request, she later transferred back to Carlyle's lance where she could, as she put it, "keep an eye on the Chief".

**Pilot:** MechWarrior Lori Kalmar

**BattleMech:**

At Trell I and Verthandi: LCT-1V *Locust*  
 At Verthandi and after: SHD-2H *Shadow Hawk*

**Skills:**

At Verthandi: <i>Piloting Skill level</i>	1
<i>Gunnery Skill level</i>	1
Against Liao: <i>Piloting Skill level</i>	2
<i>Gunnery Skill level</i>	1
Against House Marik: <i>Piloting Skill level</i>	3
<i>Gunnery Skill level</i>	2
During Orestian Campaign: <i>Piloting Skill level</i>	4
<i>Gunnery Skill level</i>	3

**BattleMech Status Report:**

Kalmar's *Locust* took heavy damage at the Battle of Thunder Rift on Trell I. During scenarios set on Verthandi, it produces 2 points of excess heat every turn, is missing two heat sinks, and has only 8 armor points on its front center torso.

At Verthandi, Kalmar moved over to Carlyle's *Shadow Hawk* when her *Locust* was destroyed and Carlyle captured a *Marauder*. By this time, the *Shadow Hawk's* left arm armor was down to 12 points, and damage to the left torso had reduced the armor value there to 10.

**MechWarrior Data:**

Lori Kalmar is a tall, blond, attractive woman who began her career on Sigurd, a bitterly cold world in Bandit King Hendrik of Oberon's empire beyond the Inner Sphere. As a raw

**Name:** Lori Kalmar  
**Age:** 25  
**Rank:** MechWarrior  
**Affiliation:** Mercenary  
**Home Planet:** Sigurd  
**Mech Type:** Shadow Hawk

**Warrior Data:**

BODY — 6    CHA — 12  
 DEX — 9    PIB — 3  
 LRN — 10    HTK — 60

Total XP: 75,000  
 XP Available: 15,000

Skills	Skill Level	Attribute Target	Modified Skill Roll Target
Brawling	4	9	5
Diplomacy	4	6	2
Gunnery/Mech	3	8	5
Leadership	4	6	2
Piloting/Mech	4	8	4
Pistol	4	8	4
Rifle	4	8	4
Streetwise	4	6	2
Survival	2	9	7
Technician	3	7	4

# COMMAND LANCE

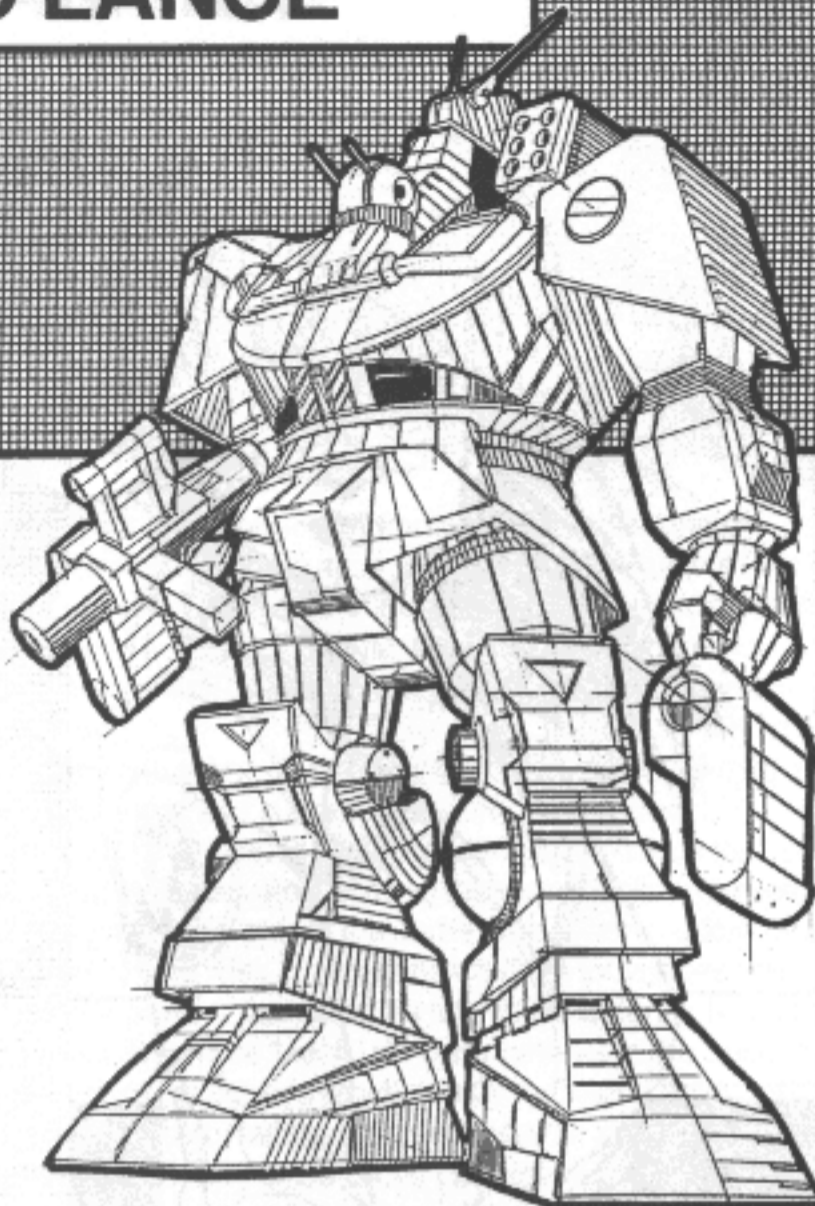
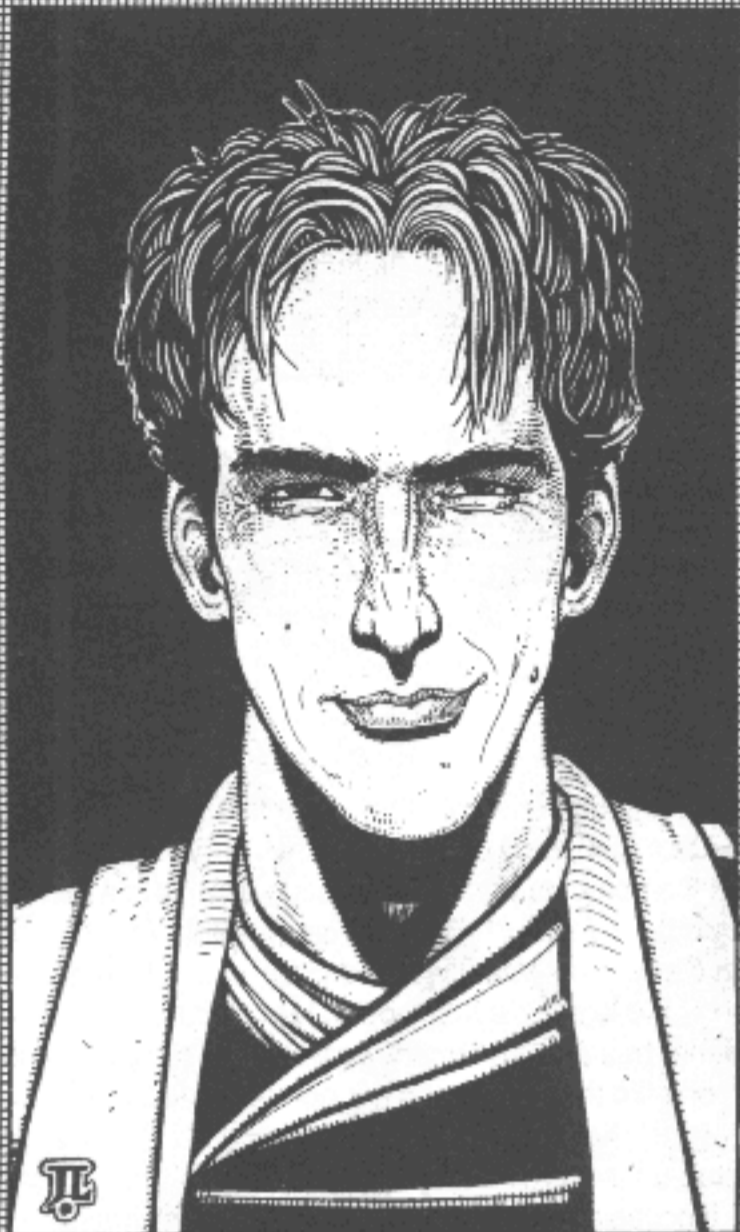

with the Gray Death Legion. If so, the problem no longer exists. At Otho, Clay's *Wolverine*, a pair of light 'Mechs, and a handful of ground troops held off a vastly superior force for the better part of an hour. During that fray, Clay was personally credited with three kills, and his *Wolverine* was reduced to a barely functional walking junkheap.

**Pilot:** Sergeant Delmar Clay

**BattleMech:** WVR-6R *Wolverine*

**Skills:** *Piloting* Skill level 3  
*Gunnery* Skill level 3  
 During Orestian Campaign: *Piloting* Skill level 4  
*Gunnery* Skill level 4

### BattleMech Status Report:

Clay's *Wolverine* has a balky Mk II medium laser. Any time the weapon is to be shot, roll 2D6 before making the To-Hit Roll. The weapon will misfire on a result of 10+, and add 3 heat points. His fusion plant produces 1 extra point of heat each turn, and there is damage in the center torso, reducing the front torso armor factor to 18. This damage was sustained on Otho, early in the Orestian Campaign.

### MechWarrior Data:

Clay was one of the first to join Carlyle's fledgling mercenary band at the unofficial Merc recruiting depot on Galatea. Initially drawn to the Gray Death Legion by the need to escape powerful and angry creditors, Clay became one of Carlyle's most loyal and trusted warriors. Offered a commission and a lance command of his own during the campaign against Liao, he refused it, saying he considered himself one of Grayson's personal bodyguards. Before joining the Legion on Galatea, Clay was a "free agent", or independent mercenary. Before that, he was a sergeant in Hansen's Roughriders, a Merc regiment in service to House Steiner.

Critics contend that Clay is actually afraid of command, with recurring rumors that he froze in combat before teaming up

**Name:** Delmar Clay  
**Age:** 35  
**Rank:** Sergeant  
**Affiliation:** Mercenary  
**Home Planet:** Gladius  
**Mech Type:** Wolverine

### Warrior Data

BODY - 10    CHA - 5  
 DEX - 8    PIH - 4  
 LRN - 9    HTK - 100

Total XP: 115,000

XP Available 18,500

Skills	Skill Level	Attribute Target	Modified Skill Roll Target
Athletics	3		
Acrobatics	3	8	5
Climbing	3	8	5
Swimming	3	8	5
Brawling	5	7	2
Gunnery/Mech	4	8	4
Leadership	1	10	9
Piloting/Mech	4	8	4
Pistol	4	8	4
Survival	4	7	3
Tactics	3	8	5
Technical	2	8	6

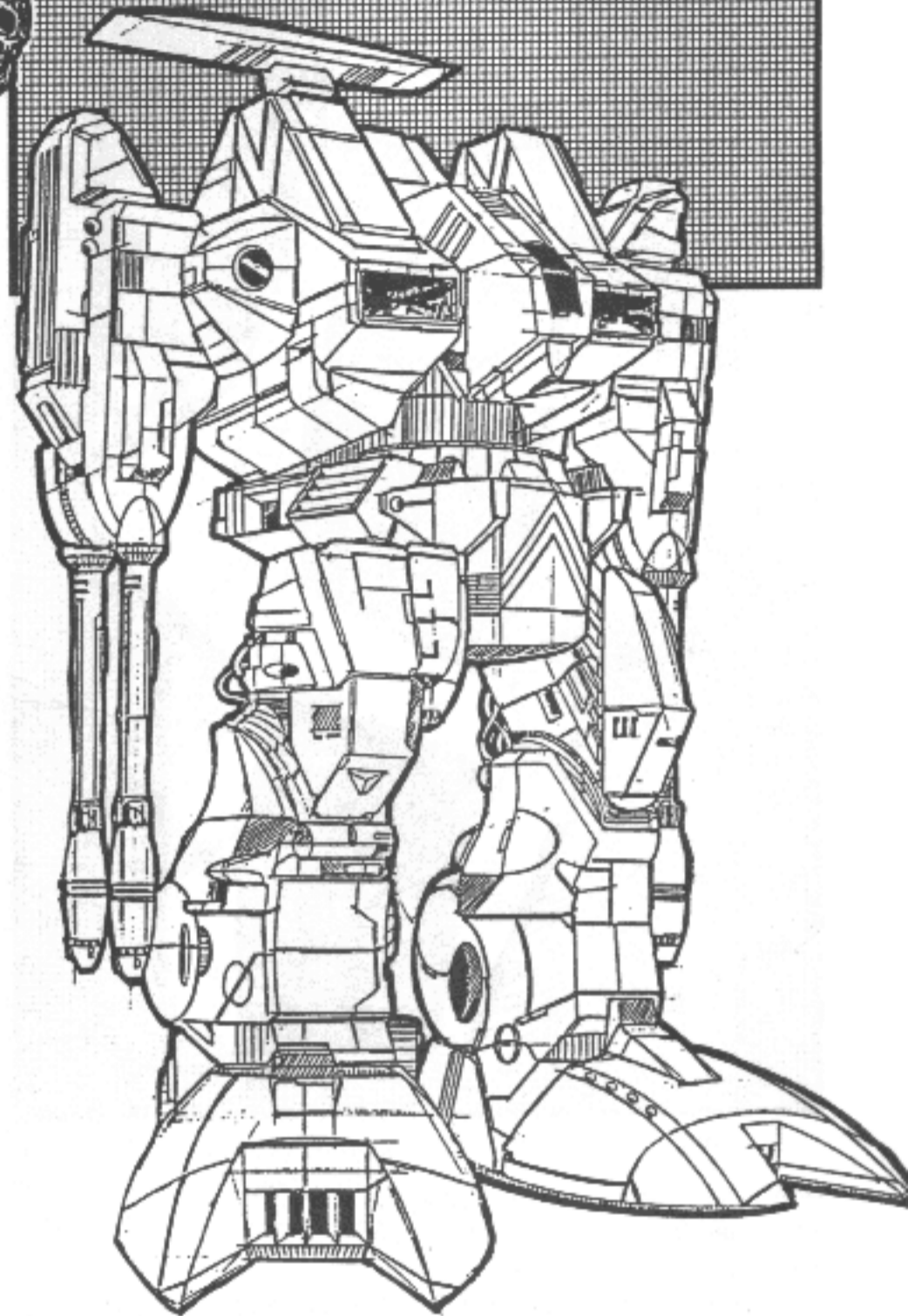

**Pilot:** MechWarrior Davis McCall

**BattleMech:** RFL-3N Rifleman

**Skills:** Piloting Skill level 3  
 Gunnery Skill level 2  
 During Orestian Campaign: Piloting Skill level 4  
 Gunnery Skill level 3

**BattleMech Status Report:**

McCall's Rifleman suffers from erratic circuitry in its left arm Magna Mk III heavy laser. Any time the weapon is to be shot, roll 2D6 to represent heat buildup. On a result of 10 or 11, the weapon produces 3 extra heat points. On a result of 12, the laser will also fail to fire. This 2D6 roll precedes the normal To-Hit Roll.

**MechWarrior Data:**

Davis Montgomery McCall was another of the unemployed mercenaries who joined the Gray Death at Galatea shortly after the Trelwan campaign. A native of Caledonia and a card-carrying member of that world's ruling Jacobite Party, McCall is fiercely proud of his Scottish ancestry and speaks with a thick Scots burr. He is a skilled MechWarrior with a penchant for charging into battle screaming Gaelic curses over his battlecom circuits.

**Name:** Davis McCall  
**Age:** 29  
**Rank:** MechWarrior  
**Affiliation:** Mercenary  
**Home Planet:** Caledonia  
**Mech Type:** Rifleman

**Warrior Data**

BODY - 11    CHA - 8  
 DEX - 8    PIB - 1  
 LRN - 9    HTK - 110

Total XP: 84,000  
 XP Available: 10,500

Skills	Skill Level	Attribute Target	Modified Skill Roll Target
Bow/Blade	4	8	4
Brawling	5	7	2
Computer	1	8	7
Gunnery/Mech	3	8	5
Mechanical	6	8	2
Piloting/Mech	4	8	4
Pistol	3	8	5
Streetwise	4	8	4
Technician	3	8	5

# FIRE LANCE

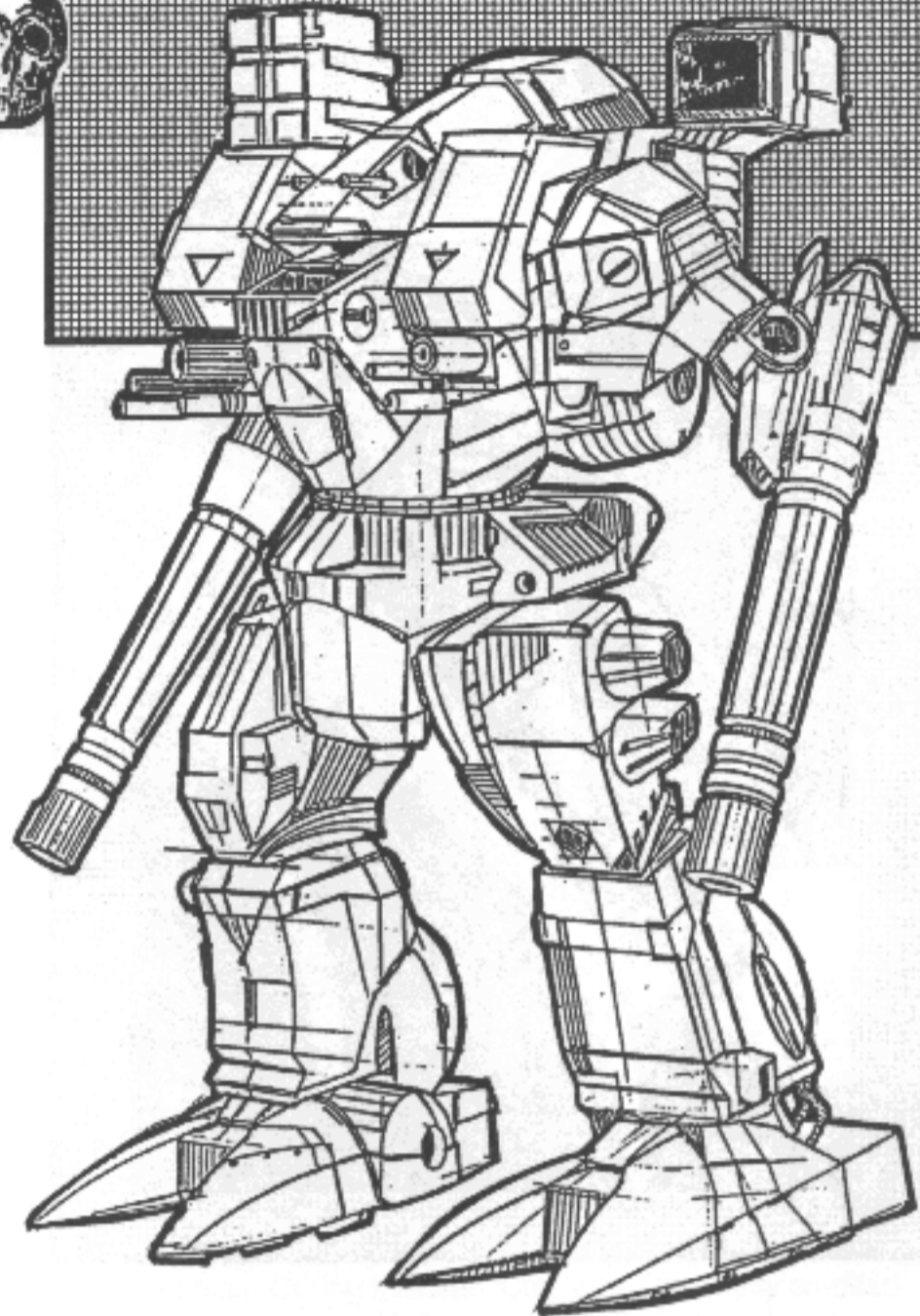

**Pilot:** Lieutenant Hassan Ali Khaled  
**BattleMech:** WHM-6R Warhammer  
**BattleMech Status Report:**

Khaled's *Warhammer* suffered severe damage to its leg actuators at Shutan in the Orestian Campaign, reducing its top running speed to 5 MP. The same battle reduced the left leg armor value to 12 points.

**MechWarrior Data:**

Hassan Ali Khaled has been a professional warrior for most of his life, having started out as a member of the dreaded Sarimaut ("Quick Death") Commandos on his homeworld of Shaul Khala. Cashiered from the Commandos under mysterious circumstances, Khaled then worked as an independent mercenary for a number of years. The three years he served with Kurita's 2nd Sword of Light have given him a keen understanding of Combine thought and tactics, an asset that Grayson Carlyle has often put to good use.

The *Warhammer* is Khaled's own, captured during a raid on Shiro and named *Aswad Sahir* (Black Sorcerer). The man himself is also known variously as the Black Sorcerer, or the Black Assassin. When the Gray Death achieved regimental status, Khaled was promoted to Captain and given his own company, which became known as Hassan's Assassins.

**Name:** Hassan Ali Khaled  
**Age:** 32  
**Rank:** Lieutenant  
**Affiliation:** Mercenary  
**Home Planet:** Shaul Khala  
**Mech Type:** Warhammer

**Warrior Data**

BODY - 9    CHA - 8  
 DEX - 8    PIB - 3  
 LRN - 11    HTK - 90

Total XP: 123,000  
 XP Available: 21,500

Skills	Skill Level	Attribute Target	Modified Skill Roll Target
Athletics	3		
Acrobatics	3	8	5
Climbing	3	8	5
Swimming	3	8	5
Bow/Blade	6	8	2
Brawling	6	8	2
Gunnery/Mech	3	8	5
Interrogation	5	8	3
Leadership	4	8	4
Piloting/Mech	4	8	4
Pistol	5	8	3
Rifle	2	8	6
Survival	5	8	3
Technician	1	7	6

# FIRE LANCE

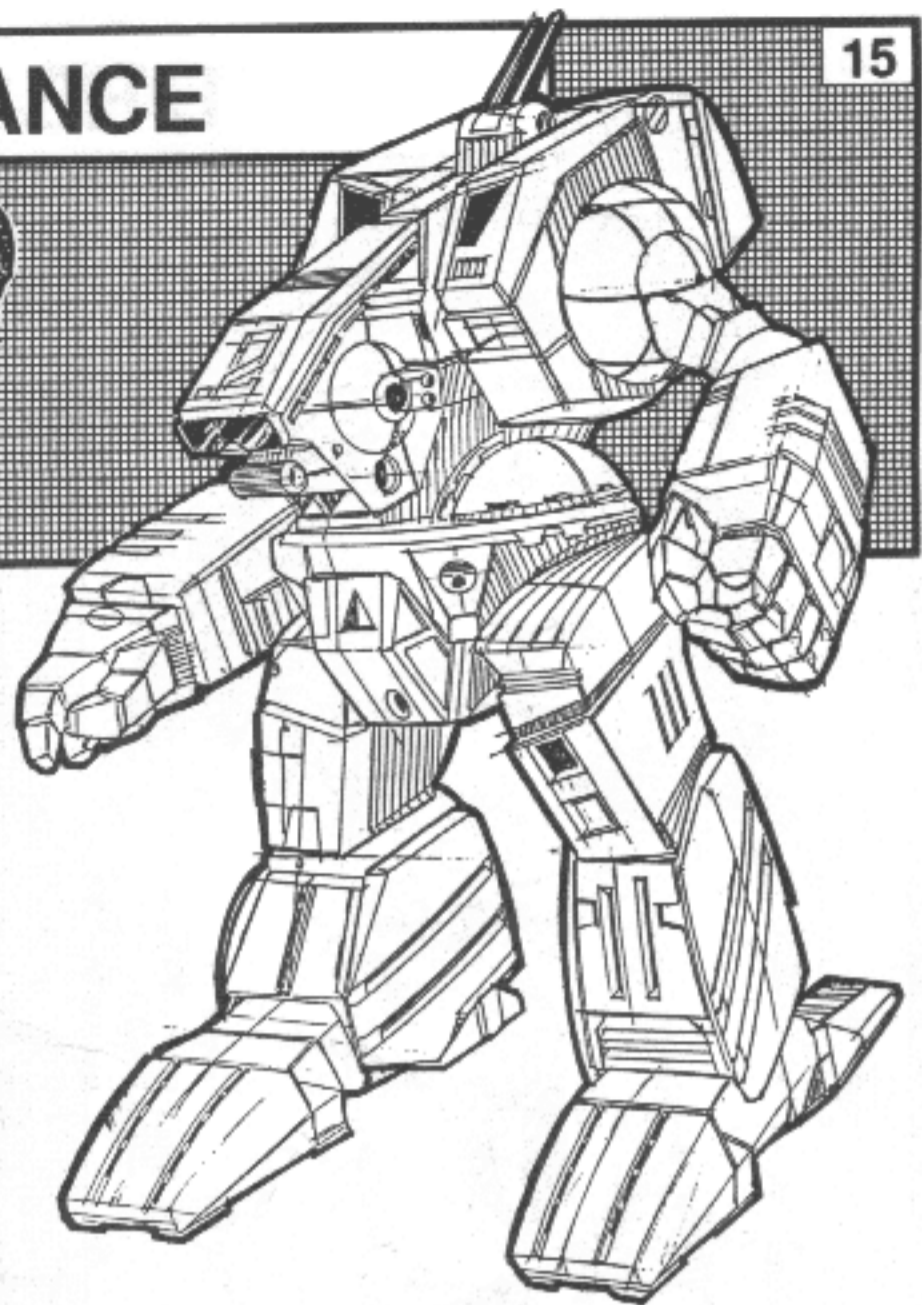

Koga is a brave and faithful warrior, but he carries within him a deep, burning hatred of Nibara Tsukuda, overlaid by a seemingly infinite patience. Tsukuda wronged Koga's father and robbed Isoru Koga of his birthright. Koga knows that someday he and Tsukuda will face each other in honorable combat. When that day comes, Koga will cleanse his family honor in blood...or die.

**Pilot:** MechWarrior Isoru Koga

**BattleMech:** ARC-2R Archer

**BattleMech Status Report:**

Koga's Archer is in perfect condition.

**MechWarrior Data:**

Koga is of Japanese ancestry, from the Terra-colonized world of Kirei na niwa. He takes very seriously the duties, honors, and responsibilities of being a warrior, which is part of the ancient code of Bushido.

Bushido, "the Way of the Warrior", stresses self-discipline, bravery, and simple living. It also requires a warrior to cleanse his honor and the honor of his family when challenged. Years ago, Koga's father, commander of a home defense militia company on Kirei na niwa, was accused of cowardice by a young MechWarrior when the planet was attacked by raiders. The elder Koga had ordered a tactical withdrawal to conserve his scattered forces while reinforcements were brought up, but the reinforcements never arrived and the militia company was all but destroyed. The elder Koga could not defend himself, and died in the battle. The charge of cowardice was enough to blacken the Koga family honor and to catapult the ambitious accuser into command of the company when it reformed. The accuser was one Nibara Tsukuda, commander of the Fire Lance, Crimson Blade Company, 5th Sword of Light Regiment.

**Name:** Isoru Koga

**Age:** 30

**Rank:** MechWarrior

**Affiliation:** Mercenary

**Home Planet:** Kirei Na Niwa

**Mech Type:** Archer

**Warrior Data**

BODY - 7      CHA - 9

DEX - 10      PIB - 6

LRN - 10      HTK - 70

Total xp: 50,000

XP Available: 7,600

Skills	Skill Level	Attribute Target	Modified Skill Roll Target
Athletics	4		
Acrobatics	4	8	4
Climbing	4	8	4
Swimming	4	8	4
Bow/Blade	6	7	1
Brawling	6	8	2
Diplomacy	2	8	6
Gunnery/Mech	3	7	4
Piloting/Mech	3	7	4
Pistol	5	7	2
Survival	3	8	5
Tactics	3	7	4
Technician	2	7	5



# FIRE LANCE

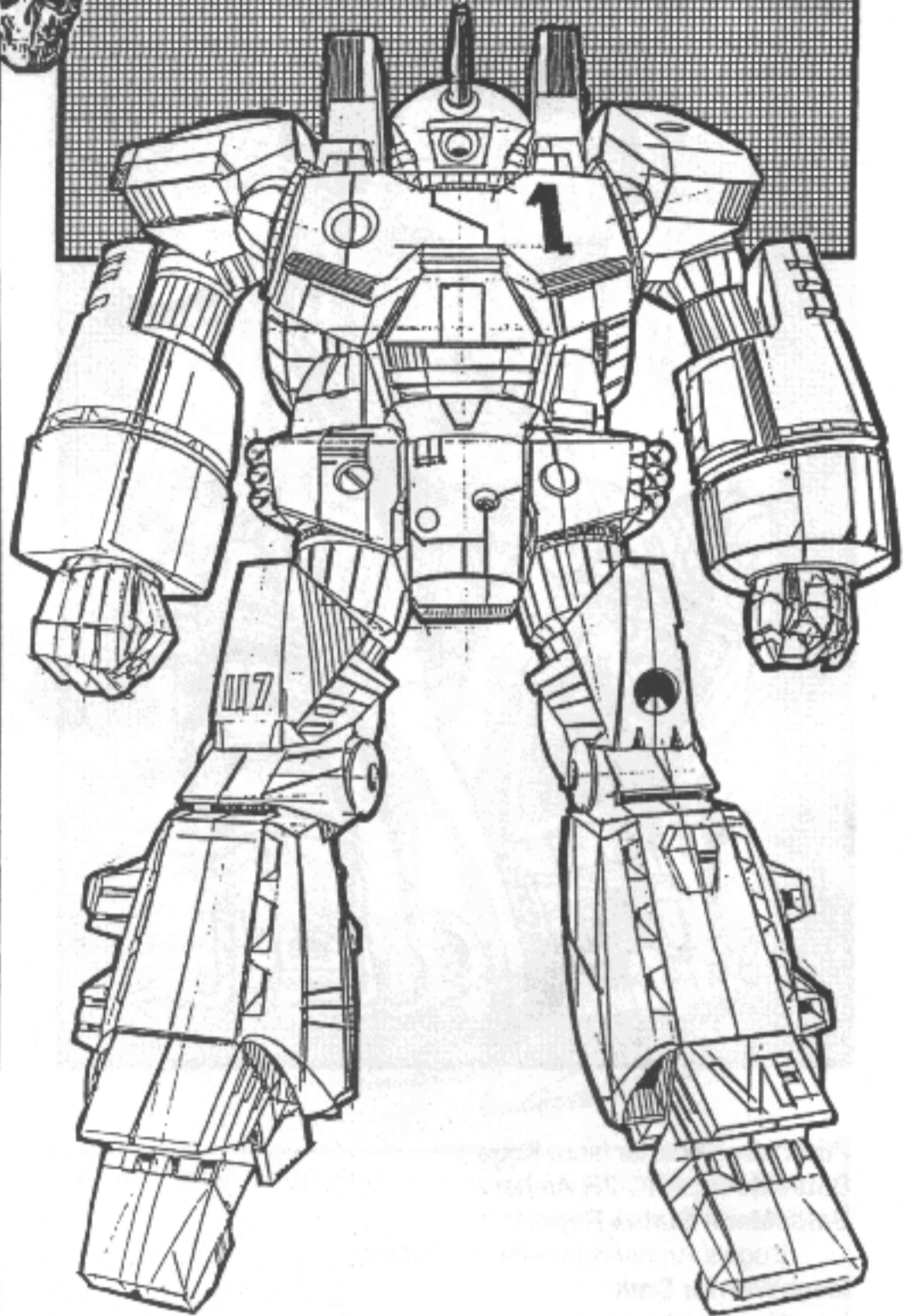
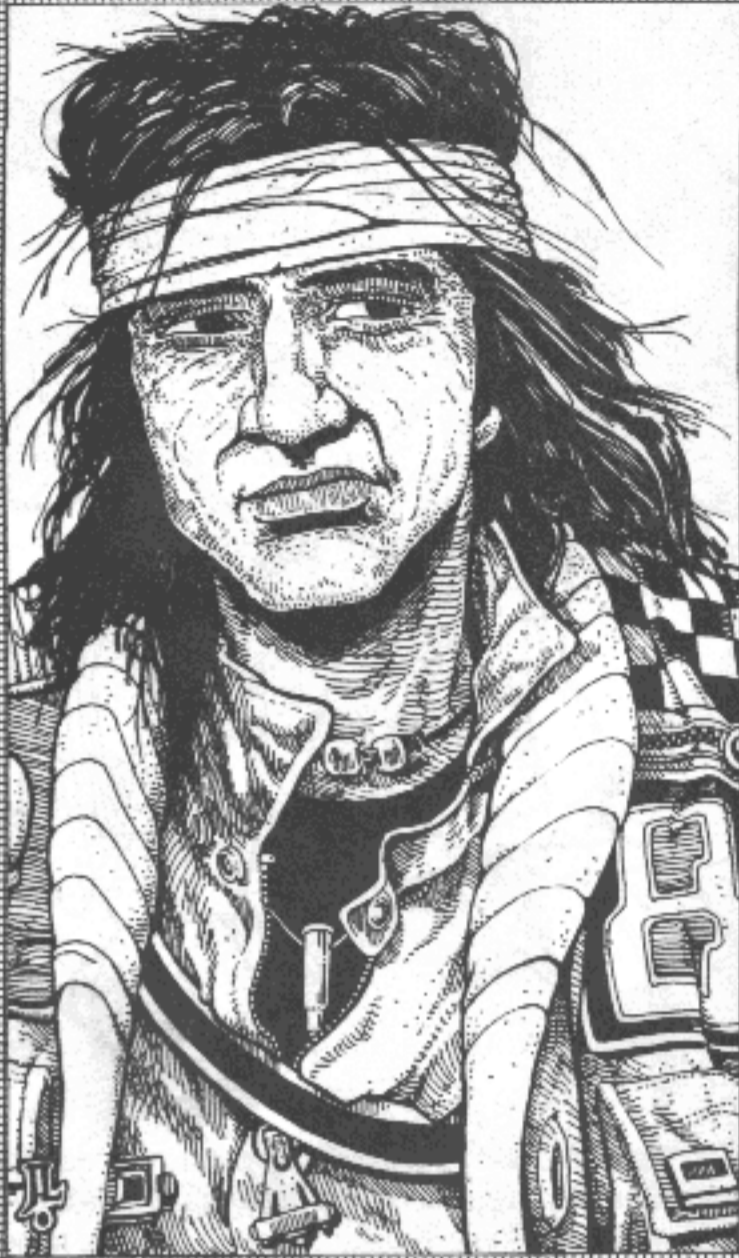

**Pilot:** MechWarrior Charles Bear

**BattleMech:** CRD-3R *Crusader*

**BattleMech Status Report:**

Bear's *Crusader* is in perfect condition.

**MechWarrior Data:**

Descendant of Native American ancestors, Charlie Bear inherited his *Crusader* from his father, who had received it from his uncle, who had received it from his grandfather, continuing a warrior tradition across three generations. Charlie Bear is a born fighter and an excellent tactician. He does not mix with the other pilots in the company, however, tending to remain aloof and removed. Though his comrades interpret this as an air of superiority, Bear is, in fact, waiting to prove himself. Though he has been in battle many times, first with the Ceti Rangers, and later with the 21st Centauri Lancers, he has yet to 'count coup'—to actually *touch* an enemy in 'Mech-to-'Mech combat.

He is biding his time, waiting for the opportunity to engage in single, close-range combat. Until that day, he will never consider himself a true warrior, son of a warrior. Bear keeps these thoughts secret, though it is unlikely that either his companions or his opponents would agree with them.

**Name:** Charlie Bear  
**Age:** 25  
**Rank:** MechWarrior  
**Affiliation:** Mercenary  
**Home Planet:** Tac Ceti II  
**Mech Type:** Crusader

**Warrior Data**

BODY — 10    CHA — 5  
 DEX — 8    PIK — 6  
 LRN — 8    HTK — 100

Total XP: 40,000  
 XP Available: 3,250

Skills	Skill Level	Attribute Target	Modified Skill Roll Target
Brawling	2	7	5
Gunnery/Mech	4	8	4
Piloting/Mech	4	8	4
Survival	2	7	5
Tactics	5	8	3
Technician	1	8	7

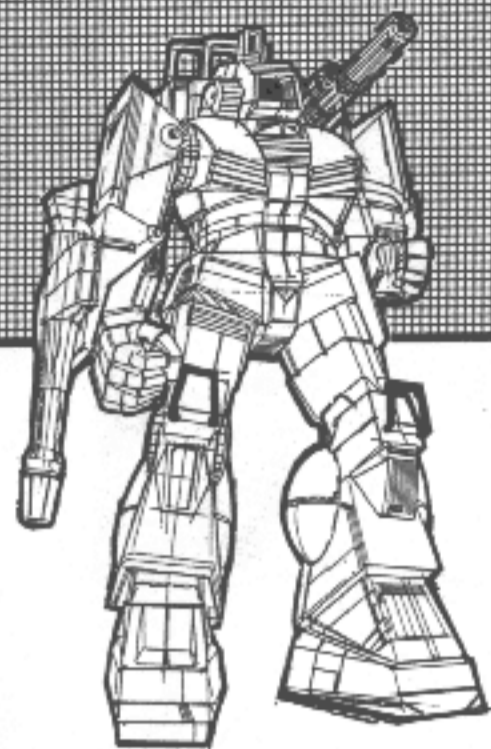

*Shadow Hawk* acquired for spare parts and served in guerrilla actions under Ian McKinnon in the month-long combat against Kurita's troops.

For her conspicuous bravery, she was awarded a handsome bonus, but McKinnon refused Sharyl's request to join the Raiders. She was not, after all, a *real* MechWarrior in the class-conscious order of Davion's 'Mech companies. Her answer was to use the bonus to buy passage offworld aboard a freighter, taking her 2D with her. Reaching Galatea, she served as a freelance mercenary in several minor conflicts, earning enough money and capturing enough salvageable wreckage to bring her *Shadow Hawk* up to full operating efficiency.

Sharyl is small, attractive, tough, and resourceful. She is driven to prove that she is as valiant as any male warrior in the Successor States, which (despite notables like Natasha Kerensky and Katrina Steiner) is becoming increasingly male-dominated. She joined the Gray Death, believing that the unit's reputation for glory and action would offer her an opportunity to prove herself once again.

**Pilot:** MechWarrior Sharyl

**BattleMech:** SHD-2D *Shadow Hawk*

**BattleMech Status Report:**

Sharyl's *Shadow Hawk* is in perfect condition. Note that this is the 2D *Hawk* variant, with less armor and more weaponry. Its stats are identical to the usual 2H model, with the following changes:

**Heat Sinks:** 14

**Armor Factor:** 72

**Armor Value:**

**Head:** 6

**Center Torso:** 12/6

**Rt./Lt. Torso:** 9/5

**Rt./Lt. Arm:** 5

**Rt./Lt. Leg:** 5

To **Weapons**, add:

1 Martel Model 5 Medium Laser (LA)

1 Holly SRM 2 (CT)

Ammo (SRM) 50 (LT)

**MechWarrior Data:**

Sharyl is a native of Dahar IV, where people do not use surnames. (If necessary for identification, she would give her name as Sharyl, Erik's daughter.) Fleeing an arranged marriage, she left her homeworld aboard a merchant freighter. Her first service came as a Tech in McKinnon's Raiders. At the Battle of Harrow's Sun, Sharyl boarded a wired-together 2D

**Name:** Sharyl

**Age:** 29

**Rank:** MechWarrior

**Affiliation:** Mercenary

**Home Planet:** Dahar IV

**Mech Type:** Shadowhawk 2D

**Warrior Data**

BODY - 4    CHA - 10  
DEX - 9    PIB - 1  
LRN - 8    HTK - 40

Total XP: 40,000

XP Available: 6,500

Skills	Skill Level	Attribute Target	Modified Skill Roll Target
Driver	3	8	5
Gunnery/Mech	4	8	4
Mechanical	4	8	4
Piloting/Mech	4	8	4
Pistol	3	8	5
Streetwise	5	7	2
Technical	4	8	4

# RECON LANCE

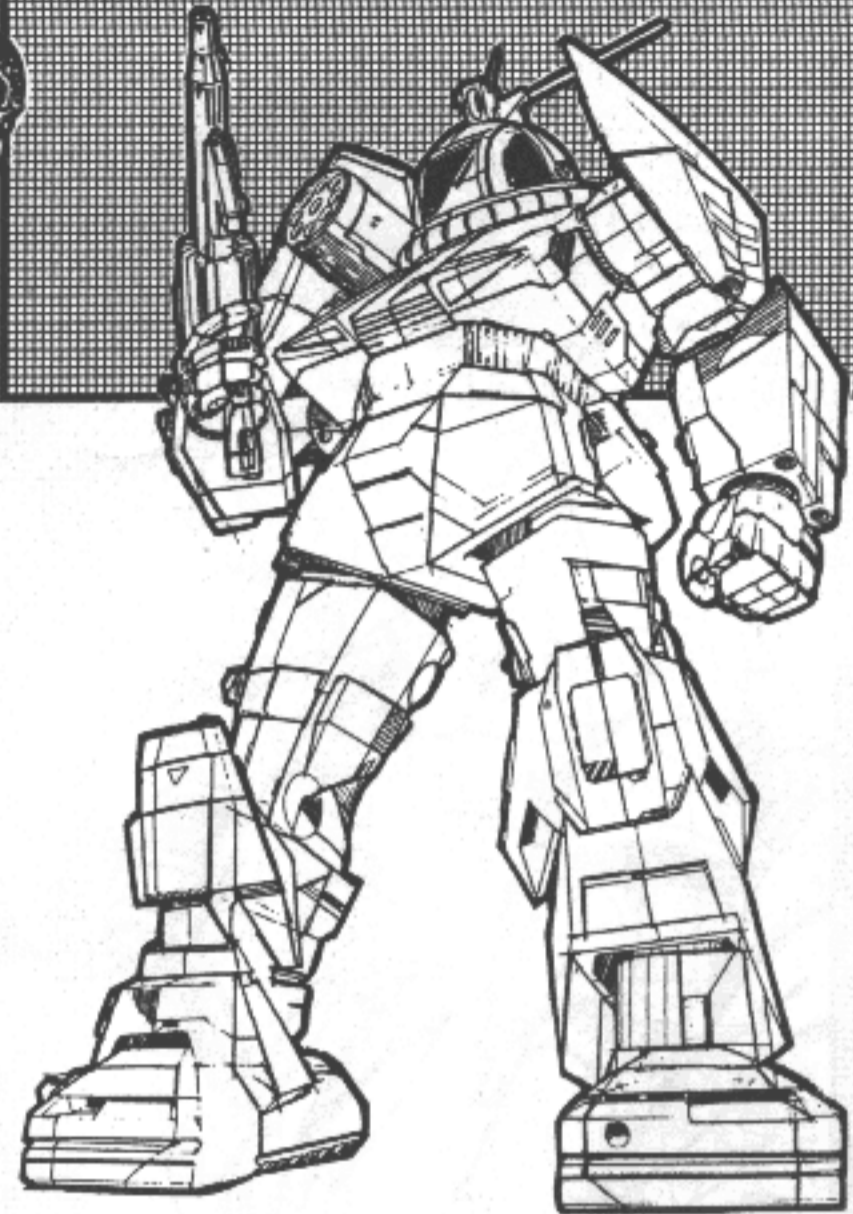

Besides knowing explosives, Gomez is a skillful and courageous MechWarrior who also works well as commander of a Recon Lance. It is said that when he is not playing with explosives, he can operate his cumbersome 'Mech with eerie silence and stealth.

**Pilot:** Lieutenant Gomez Cristobal de Villar

**BattleMech:** GRF-1N *Griffin*

**BattleMech Status Report:**

The left arm armor on De Villar's *Griffin* has been reduced to 8 points, and the armor on its left torso reduced to 15 points.

**MechWarrior Data:**

Gomez is the Gray Death's acknowledged demolitions expert. Before becoming a MechWarrior, he was an engineer specializing in demolitions work, with an emphasis in blowing holes in enemy fortifications, bridges, and buildings. As a 'Mech pilot, he has become adept at using his *Griffin's* manipulators to set explosive charges. The damage to his 'Mech's left arm and side came not from enemy fire, but from the premature detonation of a charge he was setting to trap advancing enemy 'Mechs.

Gomez's casual attitude while handling explosives has convinced most of the people who work with him that he is either mad or suicidal. They tell of how he once stacked half-kilo blocks of TNT in a campfire to win a bet with a trooper who did not know that fire cannot detonate that particular explosive. On another occasion, a former commanding officer reprimanded him for smoking while working with C-10 plastique—not because it was dangerous, but because he was thoroughly demoralizing the other troops in the unit. Gomez's seeming carelessness is deceptive, however. He is an expert, and Grayson has called upon his skill on numerous occasions.

**Name:** Gomez Cristobal de Villar

**Age:** 25

**Rank:** Lieutenant

**Affiliation:** Mercenary

**Home Planet:** Bolan

**Mech Type:** Griffin

**Warrior Data**

BODY — 6    CHA — 7  
DEX — 10    PI3 — 2  
LRN — 8    HTK — 60

Total XP: 40,000

XP Available: 7,250

Skills	Skill Level	Attribute Target	Modified Skill Roll Target
Gunnery/Mech	4	7	3
Leadership	2	8	6
Mechanical	4	8	4
Piloting/Mech	3	8	5
Rifle	4	7	3
Rogue	5	8	3
Hide In Cover	5	8	3
Stealth	5	8	3
Forgery	5	8	3
Security Systems	5	8	3
Survival	4	7	5
Technician	6	8	2

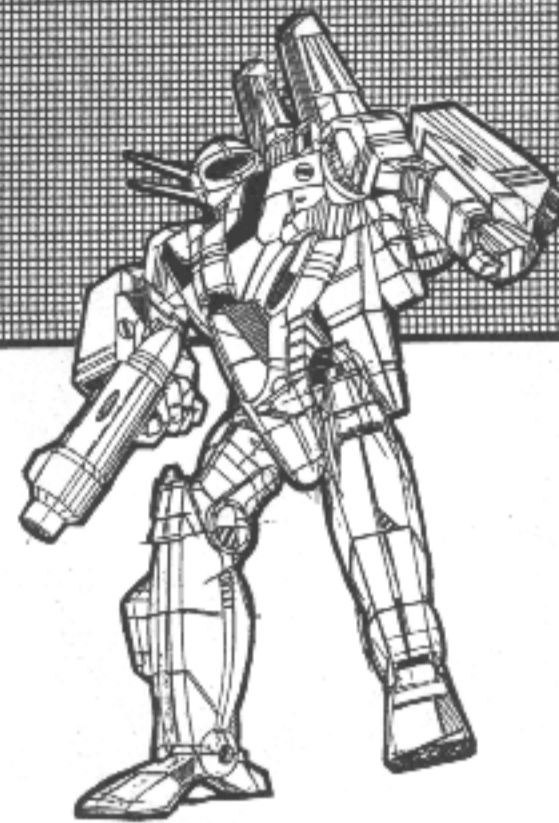

serving on the astech staff for Blackely's Blackguards, she got her chance to replace a pilot killed in combat. When the Blackguards were cashiered out after going through the meat-and-'Mech grinder on Cassias, Tracy Kent and her *Phoenix Hawk* made their way to Galatea, where she made the acquaintance of another determined young lady, Sharyl. It was Sharyl who sponsored her for the Gray Death when that unit began expanding to full regimental strength.

Unlike Sharyl, Tracy is no longer trying to prove her worth to others. Her battle is much lonelier—that of trying to prove it to herself. At Otho, she killed two heavier 'Mechs, got an assist on a third, and won both a commendation for bravery and a stiff lecture from Carlyle on recklessness. Like Carlyle, she seems to have found a new home with the Gray Death Legion.

**Pilot:** MechWarrior Tracy Maxwell Kent

**BattleMech:** PXH-1K *Phoenix Hawk*

**BattleMech Status Report:**

Kent's *Phoenix Hawk* was damaged during a raid on Juriad. For any shot using the left arm medium laser, roll 2D6 before making the To-Hit Roll. On a result of 10+, the weapon misses its target and adds 3 heat points. Also, on any shot by the left arm machine gun, roll 2D6 before making the To-Hit Roll. On a result of 9+, the ammunition feed device will freeze and render the weapon inoperable for the rest of the action. The left arm carries only 7 points of armor.

**Mech Warrior Data:**

Slim, dark-haired, well-educated, cultured, and rich, Tracy Kent is the daughter of one of the wealthiest noble families in the Federated Suns. Her carefully sheltered and well-planned-out life was shattered, however, by the death of her brother, Captain Sir Roderick Fitzroy Kent. Her decision to join the Davion military academy became the source of a bitter rift in her family. It was proper for a noble family's son to join the military, serve as an officer with a 'Mech brigade, and even die, if need be...but it was unthinkable that a proper young lady follow the same path.

Tracy disagreed, left home, and joined the academy anyway. Her father used his wealth and political influence to have her kicked out on a technicality. Instead of returning home, she joined the line infantry as a private and worked her way up to Tech Sergeant, becoming a MechWarrior the hard way, from the bottom up. After several years of training and

**Name:** Tracy Kent  
**Age:** 25  
**Rank:** MechWarrior  
**Affiliation:** Mercenary  
**Home Planet:** New Avalon  
**Mech Type:** Phoenix Hawk

**Warrior Data**

BODY — 5    CHA — 10  
 DEX — 8    PIB — 1  
 LRN — 7    HTK — 50

Total XP: 23,000

XP Available: 750

Skills	Skill Level	Attribute Target	Modified Skill Roll Target
Athletics	3		
Acrobatics	3	9	6
Climbing	3	9	6
Equestrian	3	9	6
Computer	2	9	7
Gunnery/Mech	3	8	5
Medical/First Aid	2	9	7
Piloting/Mech	3	9	6
Pistol	4	8	4
Technician	1	9	8

# RECON LANCE

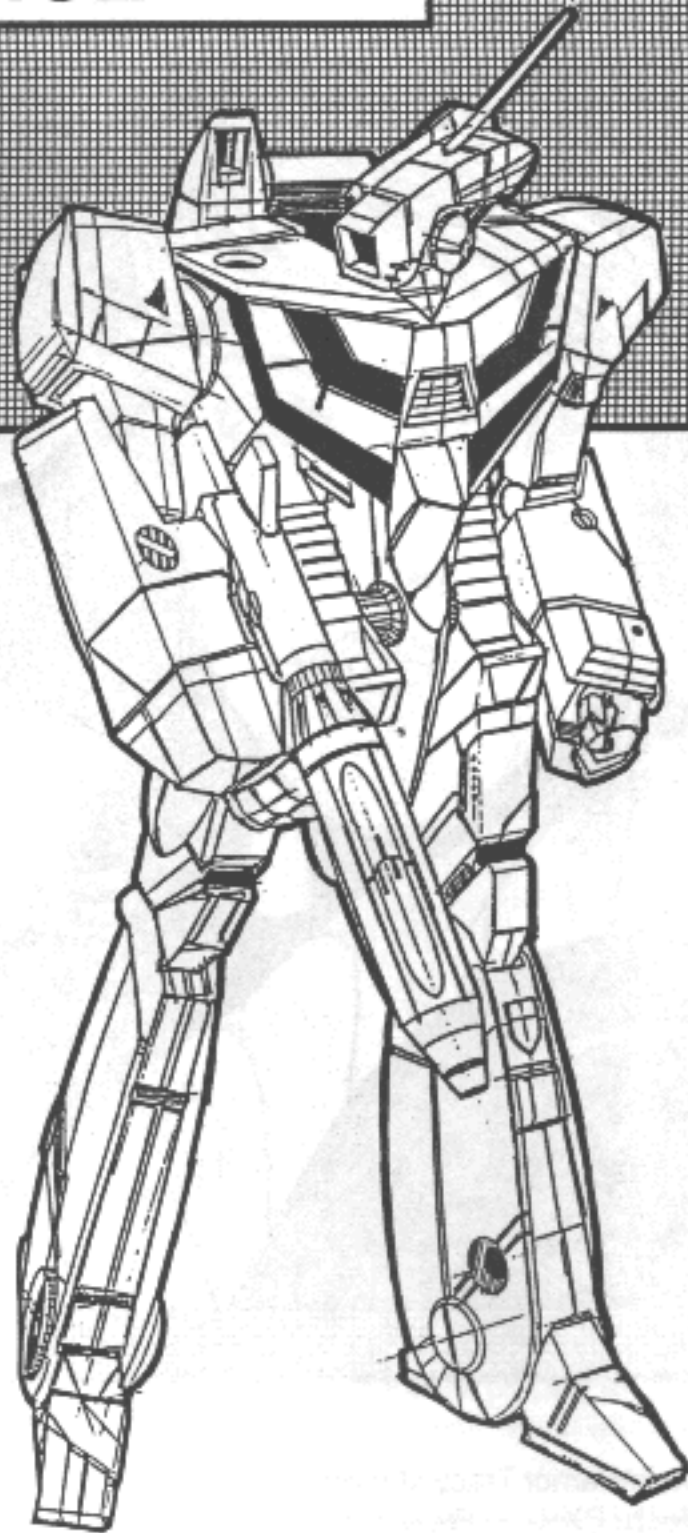

**Pilot:** MechWarrior Randolph Blake

**BattleMech:** STG-3R *Stinger*

**BattleMech Status Report:**

Blake's *Stinger* carries only 2 points of armor on its right arm, and its power plant produces 3 extra points of heat per turn. It also suffers from an untraceable fault in its gyro, which gives a +1 modifier to all *Piloting* Skill Rolls.

**MechWarrior Data:**

Randolph "Randy" Blake is a young, handsome MechWarrior who behaves with reckless abandon in both his military duties and his private life. He is a womanizer, and rumor has it that he joined the military to avoid legal entanglements brought on by his conflicting promises to three women—including a mother and her daughter.

As one of the newer members of the Gray Death, his skill in combat is yet to be proved. Nor has he been able to prove his skill as a Don Juan with the women of the unit, who are doubtless waiting to see whether there is more to him than flattery and a glib tongue.

**Name:** Randolph Blake

**Age:** 24

**Rank:** MechWarrior

**Affiliation:** Mercenary

**Home Planet:** Tharkad

**Mech Type:** Stinger

**Warrior Data**

BODY — 7    CHA — 9  
DEX — 7    PIB — 0  
LRN — 6    HTK — 70

Total xp: 8,000

xp Available: 750

Skills	Skill Level	Attribute Target	Modified Skill Roll Target
Athletics	3		
Acrobatics	3	8	5
Climbing	3	8	5
Swimming	3	8	5
Brawling	1	8	7
Diplomacy	3	8	5
Gunnery/Mech	3	8	5
Piloting/Mech	3	8	5
Pistol	3	8	5

# RECON LANCE

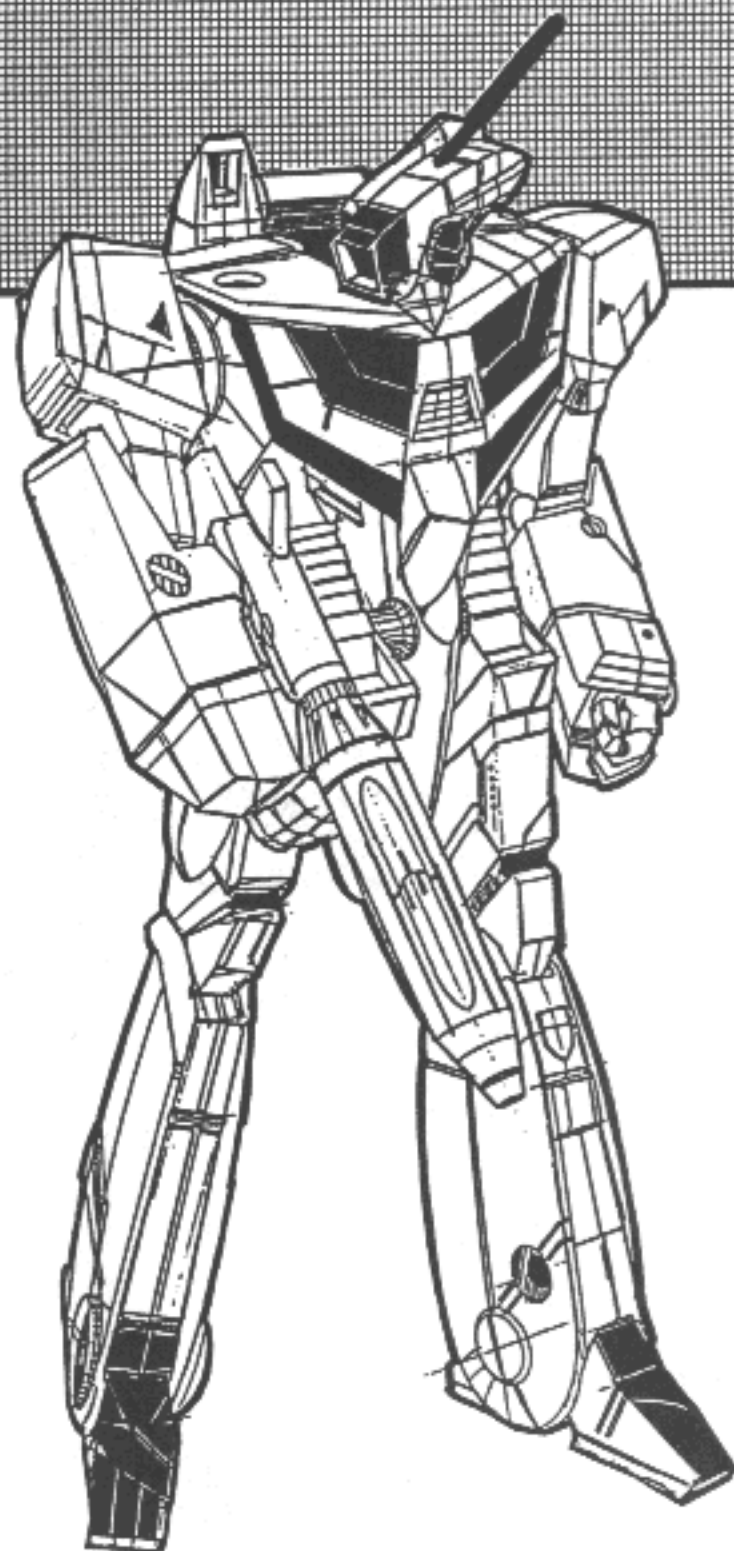

**Pilot:** MechWarrior Apprentice Erin Sharpley

**BattleMech:** STG-3R *Stinger*

**BattleMech Status Report:**

Sharpley's *Stinger* carries only 3 points of armor on its right torso, and 5 points of armor on its center torso. An untraceable fault in its jump jets cuts out the impulse jet at inopportune times. Before making a jump attempt, roll 2D6. On a result of 9+, reduce the \*Mech's Jump MP to 2.

**MechWarrior Data:**

Sharpley is another raw recruit, youngest son of a MechWarrior in service to House Marik. Having served Carlyle for several years as an apprentice and company astech, he combines the usual traits of novice warriors facing combat for the first time: determination freely mingled with stark terror. His greatest fear is that he will freeze while his lance is depending on him. Sharpley will retain the rating of "apprentice" until he has proven himself in combat.

**Name:** Erin Sharpley  
**Age:** 20  
**Rank:** MechWarrior Apprentice  
**Affiliation:** Mercenary  
**Home Planet:** Tharkad  
**Mech Type:** Stinger

**Warrior Data**

BODY — 7    CHA — 7  
 DEX — 6    PIB — 0  
 LRN — 6    HTK — 70

Total XP: 1,000

XP Available: 1,000

Skills	Skill Level	Attribute Target	Modified Skill Roll Target
Gunnery/Mech	1	9	8
Piloting/Mech	1	9	8
Technician	1	9	8

# ALONE ON TRELLWAN

## TRIAL BY FIRE

The black and gray *Marauder's* eight-meter legs gave it a tall and spindly look, and its dorsal-mounted autocannon rose a full two meters above Grayson's cockpit. Of all the BattleMech designs, Grayson thought, the *Marauder* looked the most sinister, the most deadly. The movement of scanner antennae on either side of its low-mounted cockpit suggested the twitching mouthparts of some monstrous biped crab. Each arm, with vastly swollen vambrace and gauntlet to accommodate the paired PPCs and lasers, was the image of raw, unstoppable power.

Grayson stared at the apparition with mingled fear and hatred. Challenging a *Marauder* with a *Shadow Hawk* was a risky business. The *Marauder* outweighed him by 20 tons, and its twinned lasers and PPCs seriously outgunned the *Hawk's* weaponry. Grayson's advantages, however, were his speed, maneuverability, and consuming need for revenge. Indeed, that need had grown to such a storm-fury that he swung the *Hawk* about to fully face the newcomer, urging it forward in a ground-eating trot.

There was a burst of static in his helmet earphones as someone sought his combat frequency. Then he heard the electronic voice of his opponent, saying, "We knew you would come, Carlyle. We were ready for you."

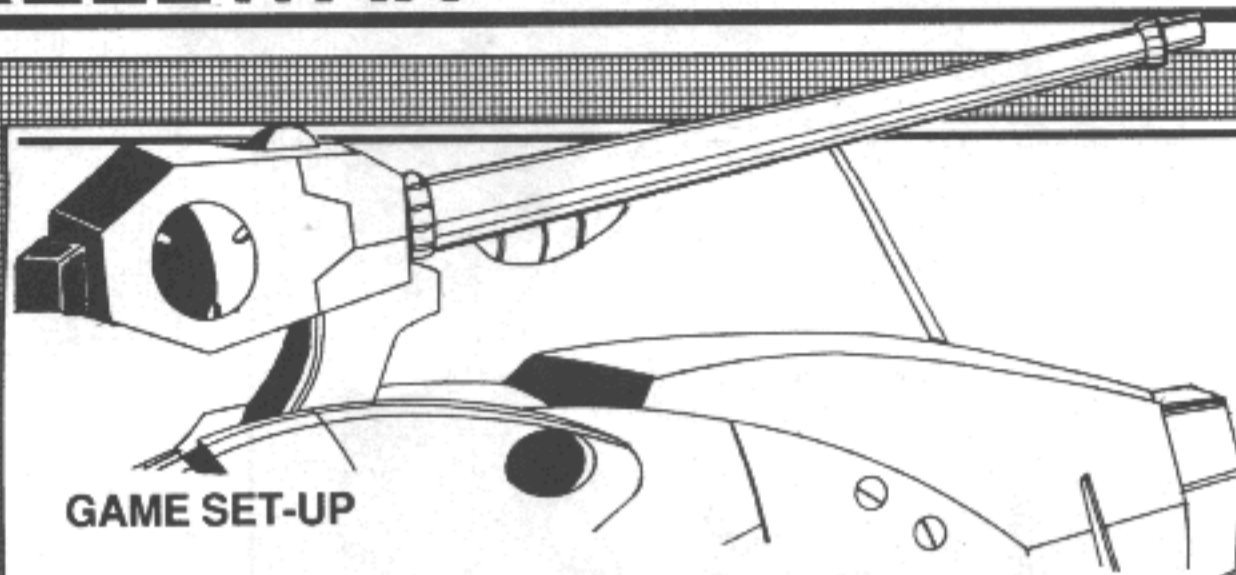
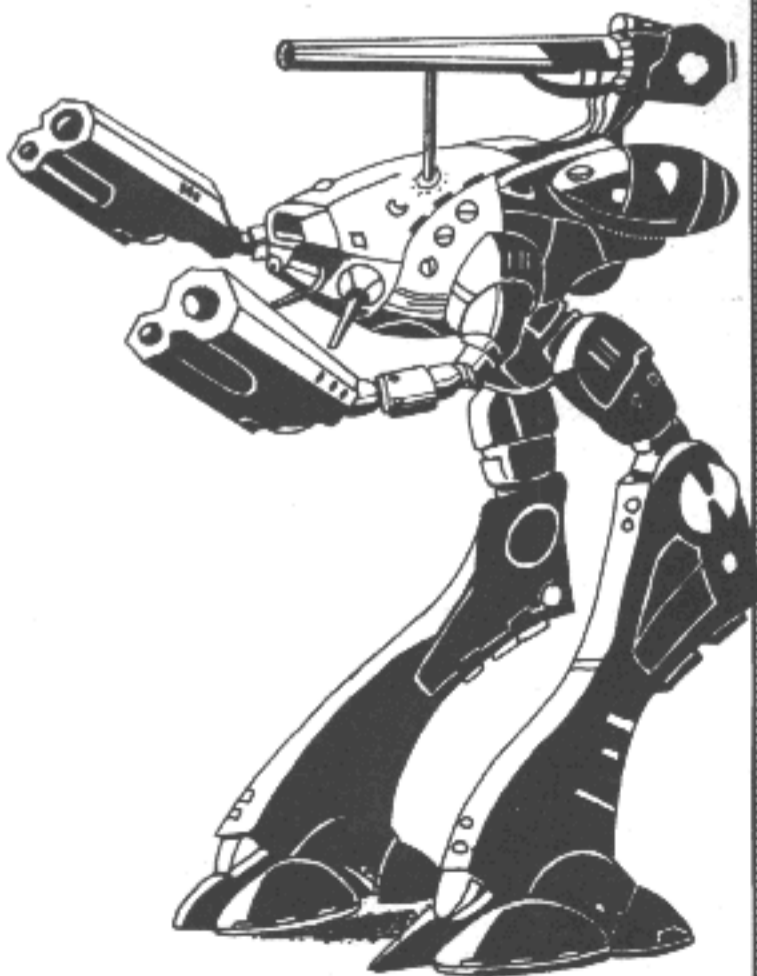

Lay out the two **BattleTech** maps in the configuration shown. Ignore all terrain markings, treating Water, Rough, Elevation, and Vegetation hexes as Clear terrain. The square on the East Map delineated by Hex Numbers 0507, 0907, 0512, and 0912 on Map 2 is a tank farm containing storage tanks of liquid hydrogen, aviation fuel, and other flammable or explosive liquids.

Fill out 'Mech record sheets for the three 'Mechs in this action.

### Defender

The Defender is a lone *Shadow Hawk* piloted by the young Lieutenant Grayson Carlyle. His 'Mech is undamaged, at least so far. He begins the scenario on Map 1, on any hex of his choosing along the west edge of the map. The Defender sets up first.

### Attacker

The Attacker includes elements of Duke Hassid Ricol's garrison force on Trell, guarding the Sarghad spaceport. The Attacker's force is made up of the following:

- 1 *Crusader* (Lord Harimandir Singh)
- 1 *Marauder* (Lieutenant Vallendel)

The Attacker sets up his *Crusader* anywhere on Map 1 seven hexes away from the initial location of the Defender's *Shadow Hawk*. Play begins immediately after the *Crusader* has fired a missile salvo from a range of 220 meters, doing no serious damage.

The *Marauder* is held back on the first three turns, but may enter on Turn 4 or after, from any hex on the north, south, or west edge of Map 1.

### Victory Conditions

The Attacker wins by destroying the *Shadow Hawk*. He wins a marginal victory if the *Shadow Hawk* escapes off the east edge of Map 2, with all but one of its weapon systems knocked out.

The Defender scores 20 points for exiting off the east edge of Map 2. He subtracts 5 points for each weapon system (autocannon, LRM, SRM, medium laser) knocked out in the battle. He scores a bonus of 10 points for destroying the *Crusader*, and 25 points for incapacitating the *Marauder* (immobilizing it, destroying it, or killing the pilot).

Basically, the Defender wins by escaping with his 'Mech more or less intact off the east edge of Map 2. Use the Victory Table to judge his success.

#### VICTORY TABLE

Points	Result
25 or more	Spectacular Success
15 - 24	Major Victory
10 - 14	Marginal Victory
1 - 9	Defeat
0 or less	Utter Defeat

## SITUATION: 49 HOURS PAST LOCAL SUNRISE, THIRDDAY, TREL I, NOVEMBER 3024

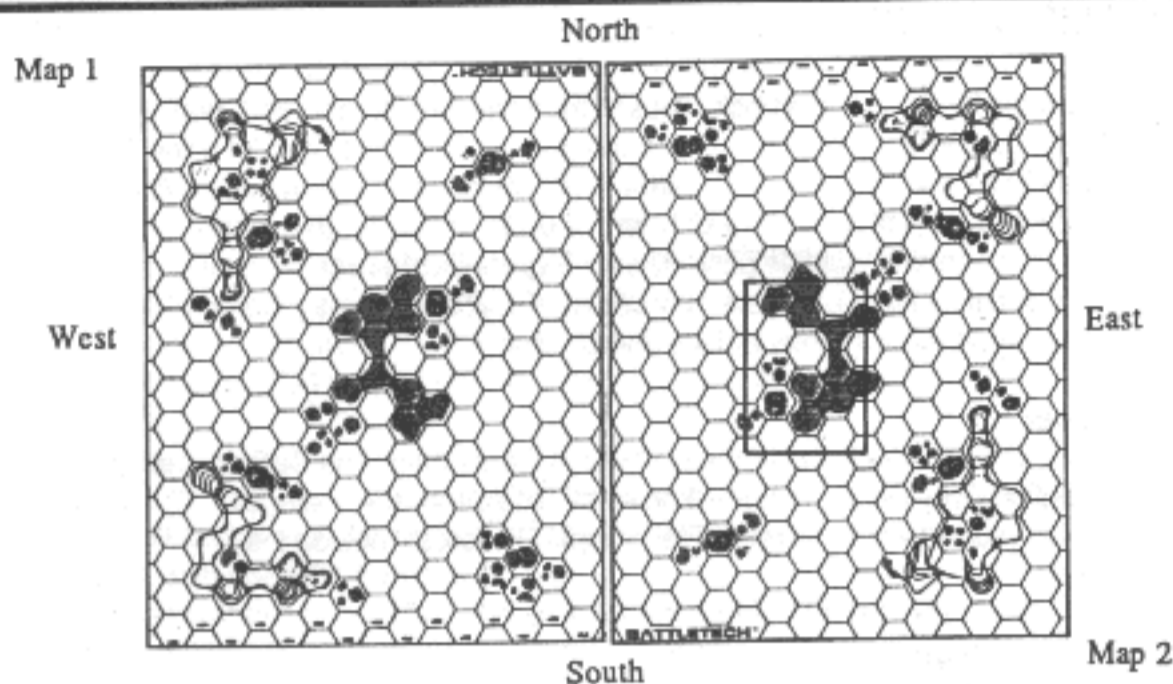

### Special Rules

**The Tank Farm:** The tank farm consists of rows of large, squat, metal tanks of hydrogen and other fuels for spacecraft and vehicles at the spaceport. Neither the *Marauder* nor the *Crusader* will fire into the tank farm area for fear of setting off a catastrophic explosion.

The fuel tanks block line-of-sight. 'Mechs may engage in combat within the tank area only when they are adjacent, and only by kicking or punching. Jump jets may not be used within the tank area.

Movement within the farm is at the rate of one hex per turn. Movement is secret, with each player noting the hex to which his 'Mech moves in that turn, then comparing the hex number or numbers with his opponent after movement. Thus, during each Movement Phase, each player knows where the other player was after the last Movement Phase, but not to which of six possible hexes he is moving in *this* phase. If opposing 'Mechs are in adjacent hexes after hex numbers have been compared, combat begins. If 'Mechs are in the same hex, the movement is disallowed.

Firing into any tank farm hex will result in an explosion. The explosion will attack with 100 points of damage all 'Mechs within tank farm hexes. This damage should be divided up as ten attacks causing 10 points of damage each, with damage allocated as for normal attacks. To determine which general area of the 'Mech suffered a hit, roll 1D6 (1 = left side; 2-3 = front; 4-5 = back; and 6 = right side). In addition, the explosion will add 10 x 2D6 points of heat to each 'Mech immediately caught in the blast.

All 'Mechs caught within one to two hexes of a tank farm hex when the tanks explode suffer 40 points of damage, divided as four attacks of 10 points each delivered against the side of the 'Mech facing the explosion. They also receive 5 x 2D6 points of heat from the flames.

All 'Mechs caught within three to four hexes of an exploding fuel farm suffer 10 points of damage, delivered as a single attack against the side of the 'Mech facing the explosion. The 'Mech also suffers 2D6 points of heat.

The Defender's strategy must be to use the fuel tank farm as a barrier to keep the enemy from crippling him with long-range fire and, if possible, to lure the enemy into the tank area, escape, and use the farm as a gigantic bomb to cripple or destroy his opponents.

The Attacker must maneuver his slower 'Mechs to prevent the *Shadow Hawk's* escape, crippling the lighter 'Mech if possible to prevent it from reaching the tank farm or the edge of the map.

### Optional Special Rule

If the *Shadow Hawk* sustains any damage in this action, record it and apply it to the reinforcing *Shadow Hawk* in the next scenario, **Decision At Thunder Rift**.

The climactic moment in the Trelwan Campaign required a precisely-timed, three-part operation against Duke Hassid Ricol's planetary garrison. At the system's jump point in space, a DropShip posing as a routine courier flight approached an enemy-held freighter needed for Grayson's plan. At Thunder Rift, Lori Kalmar and three 20-ton scout 'Mechs would have to keep a far larger force of enemy machines occupied while Grayson Carlyle carried out his role in the operation. Carlyle's target was a deep-space communications ground station at the Sarghad spaceport. That station had to be destroyed at a precise time. Too early, and the target ship at the jump point would become suspicious of approaching spacecraft while communications with Trel I were out. Too late, and the ship commander would warn the ground commander that he was under attack.

The ground phase of the operation went well. Kalmar decoyed an estimated full company of BattleMechs after her toward Thunder Rift, several kilometers north of the Sarghad port. Carlyle destroyed the ground station at the required moment, then began his withdrawal to join Kalmar at Thunder Rift.

The sudden appearance of an enemy *Crusader* blocked Carlyle's withdrawal, however. As they duelled, a second enemy 'Mech arrived—the dreaded 75-ton *Marauder* that had already been responsible for the death of Carlyle's father a few months before.

Carlyle was torn by the desire for revenge and the knowledge that a *Shadow Hawk* could not possibly hope to take on a *Marauder* and survive. Worse, he knew that Lori Kalmar would be hard-pressed by the enemy attack on Thunder Rift, and that his 'Mech and its intact weapons would be needed there.

He had only seconds in which to make his decision.





# DECISION AT THUNDER RIFT

## OUTNUMBERED, OUTWEIGHED

The enemy 'Mechs were visible now. The four they'd seen before, plus three more. These were a *Stinger*, a *Shadow Hawk*—for one leaping instant, Lori thought it was Grayson come up the hill to their rescue—and the lead 'Mech, a *Marauder* painted red, with black legs and trim.

So, Lori thought, Duke Ricol was here in person!

"Fire!" Lori shouted, but the command was lost in the first volleys of laser and missile fire. Her own laser snapped off four shots, and three of them scored on the already-damaged *Griffin*, shredding armor, opening new wounds in the huge machine's arms and torso. The Duke's men were not using the scattered boulders for cover this time, but were running uphill at top speed, hoping, she realized, to overrun the Lancers' position before they themselves took unacceptable losses.

"They're trying to swamp us!" she said. "Pour it on!"

The *Griffin* stumbled and fell, whether destroyed or damaged badly, she could not tell. Switching her sights to the *Marauder* advancing ponderously in the vanguard, Lori watched in horror as the 'Mech's head and torso absorbed bolt after bolt, seemingly without effect.

Then she realized that the *Stinger*—far faster and more agile than the *Marauder*—was closer, was almost on top of her position. She swung her laser up and caught the 20-ton 'Mech in the leg. Then her own 'Mech reeled as the PPCs mounted in the *Marauder's* forearms loosed thunder and fire at the cockpit of her *Locust*, smashing Lori to one side in her seat, and tilting the 'Mech over to its port side.

Lori screamed...



### GAME SET-UP

Lay out the two **BattleTech** maps in the configuration shown. Treat the Water and Vegetation Hexes as rough ground. All hexes north of a line between 0101 and 1501 on Map 2 are water. The dividing line between Maps 1 and 2 is the crest of a ridge. All of Map 1 is uphill, going south to north.

This scenario should be played using **Expert BattleTech** rules. If desired, and if available, players may use the **CityTech** Infantry Combat Rules to supplement infantry moves and combat.

#### Defender

The Defender sets up first, anywhere on either map. The Defender is the fledgling Gray Death Legion—known at this time as the Trelwan Lancers—plus a handful of rebel Trel troops. His forces include the following:

Kalmar's *Locust*

1 *Stinger*

1 *Wasp*

2 HVTs, 5 HVWCs, and 6 hoverscouts (described below)

On Turn 10, roll 1D6. On Turn 10 + 1D6 (Turn 11 through 16), the Defender gets the following as reinforcements anywhere on the east, south, or west edge of Map 1: 1 *Shadow Hawk* (Grayson Carlyle)

All 'Mechs are in good condition. Damage noted in the BattleMech Status reports has not yet been inflicted.

#### Attacker

The Attacker begins the first turn with the following:

1 *Griffin* (Center Torso Armor 12. LRM reloads reduced to 10.)

2 *Phoenix Hawks*

1 *Rifleman* (7 Heat Sinks. Right Arm destroyed)

1 *Wolverine* (SRM reloads reduced to 8.

Right Arm Armor reduced to 9.)

1 *Locust*

On Turn 10, he gets the following reinforcements:

1 *Stinger*

1 *Shadow Hawk*

1 *Marauder* (10 Heat Sinks remaining. Left Leg Armor 8.)

These forces represent the survivors of a full company of BattleMechs ambushed earlier by Trel forces commanded by Duke Hassid Ricol (the *Marauder*).

#### Victory Conditions

The Attackers win if they can wipe out the three light 'Mechs defending the ridgetop before Carlyle arrives with his *Shadow Hawk*, OR if they can wipe out all four Defender 'Mechs before Turn 20, while losing NO MORE THAN 180 total tons of their own 'Mechs.

The Defenders win by avoiding the Attacker's victory conditions AND if the *Shadow Hawk* survives the combat. Any other result is a draw.

#### Special Rules

The Defender has the initiative. The players may, if they wish, utilize the **City Tech** Infantry Combat Rules to expand upon the ground combat in this scenario.

The east and west borders of Map 2 are the walls of a deep rift valley and cannot be climbed. On the north border lie a deep lake and a high waterfall, which block exit in that direction.

**Explosives:** Before the scenario begins, the Defender may secretly note the numbers of any six hexes on Map 1. They may be adjacent to one another or scattered about the board. Explosives have been planted here in

## SITUATION: 50 HOURS PAST LOCAL SUNRISE, THIRDDAY, TREL I, NOVEMBER 3024

front of the enemy's advance. They may be detonated at any time during the scenario by any defending 'Mech or vehicle with a direct line-of-sight to any one of the mined hexes. All hexes must be detonated at the same time.

Detonating the explosives does 2D6 points of damage to each 'Mech occupying that hex, and 1D6 points of damage to each 'Mech in any adjacent hex. Each damage value is rolled separately for each 'Mech caught in the blast. Roll 1D6 to determine the damage locations on 'Mechs (1 = left side; 2 - 3 = front; 4 - 5 = back; and 6 = right side.) To determine Hit Location, roll 2D6 against the Hit Location Table, and subtract 2 from the result.

**Heat:** The Defenders are close to a large, cold body of water from which a stiff, cold wind is blowing. This helps ease the heat build-up in their 'Mechs. Halve all heat points acquired by any 'Mech on Map 2 (only) in any one turn, with fractions rounded up.

The southern slope (Map 1) is quite steep. All 'Mechs must expend 2 MP for each hex moved in an uphill direction. Walking uphill adds 2 heat points per turn. Running adds 4 per turn.

**Defending Hovercraft:** The Defender has a force of lightly armored hovercraft mounting missile launchers and PPCs. Use 13 cardboard counters or similar markers to represent five HVWCs (Hovercraft Weapons Carriers), two HVTs (Hovercrafts), and six hoverscouts. HVWCs and HVTs have 6 MP per turn; scouts have 12. All may travel freely over water or up or down the Map 1 slope, but may not enter rough terrain.

HVWCs mount either one large laser or one LRM (10) with 24 reloads (Defender's choice). HVTs mount one PPC and one SRM (6) with 25 reloads. Hoverscouts carry one medium laser.

HVTs are rendered immobile by one hit from any BattleMech weapon (except machine guns, but including a kick or punch), but can continue to fire. A second hit destroys them. HVWCs and Hoverscouts are destroyed by one hit from any BattleMech weapon (except machine guns). Because of their size and speed, there is an automatic +3 added to the Base To-Hit number of all vehicles when in motion.

**The Slope:** The crest at the top of the slope forms a hillcrest dead zone. 'Mechs shooting uphill cannot shoot farther than one line of hexes into Map 2 unless they are themselves in a hex adjacent to Map 2. 'Mechs and vehicles on top of the slope cannot fire at 'Mechs downhill unless they are in a Map 2 hex that is adjacent to Map 1.

### Optional Special Rules

**Carefully Aimed Fire:** In the actual battle, the Trel *Stinger* and *Wasp* gained an advantage by lying prone and firing with great care. All medium laser shots from the Defender's *Stinger* or *Wasp* subtract 2 from their Base To-Hit numbers if the 'Mechs are prone and firing downhill from the top of the ridge.

**Shadow Hawk Damage:** In the historical battle, Carlyle's *Shadow Hawk* arrived on the field after having fought a pair of heavy 'Mechs at the enemy spaceport. Players may wish to link these two engagements, having the Defender's reinforcing *Shadow Hawk* arrive on the field with the damage it acquired in the scenario *Alone On Trelwan*. If the *Shadow Hawk* is destroyed or crippled in the first scenario, Kalmar's little band will be entirely on their own in the second.

**CityTech Vehicle Rules:** Players with access to FASA's *City-Tech* may substitute the vehicle rules from that game for the simplified hovercraft rules given above. The HVTs weigh 50 tons each, HVWCs weigh 25 tons each, and hoverscouts each weigh 10 tons. Their weapons are the same as those described above under **Defending Hovercraft**. All other design features are at the discretion of the Defender.

The climactic Battle of Thunder Rift forced Duke Ricol to give up his ambitions to build a secret military staging area deep within Lyran Commonwealth territory. Though shockingly outnumbered by 'Mechs far larger and more heavily armed than her own, Sergeant Lori Kalmar fought a stubbornly tenacious delaying action up the slope before Thunder Rift, withdrawing at last to the narrow mouth of the canyon opening. There she could make use of the cooling breeze and water within the Rift to keep her 'Mechs cool, with an excellent vantage point from which to fire down on her more numerous adversaries struggling up the south slope.

It was a lopsided battle, however good her position. Three 20-ton 'Mechs and a handful of armed hovercraft could not last long against a full company of medium and heavy BattleMechs! Her single hope was a slender one: if Grayson Carlyle could complete his mission at the nearby starport, if his *Shadow Hawk* survived its solo combat there, his sudden arrival in the enemy's rear might—might!—tip the balance if her own defense had weakened and demoralized them enough.

But what of the dictates of BattleMech combat doctrine, born of a thousand battles on numberless worlds, and proven true again and again? According to that wisdom, light recon machines—*Stingers* and *Wasps* and *Locusts*—don't stand a chance in combat with medium and heavy 'Mechs!

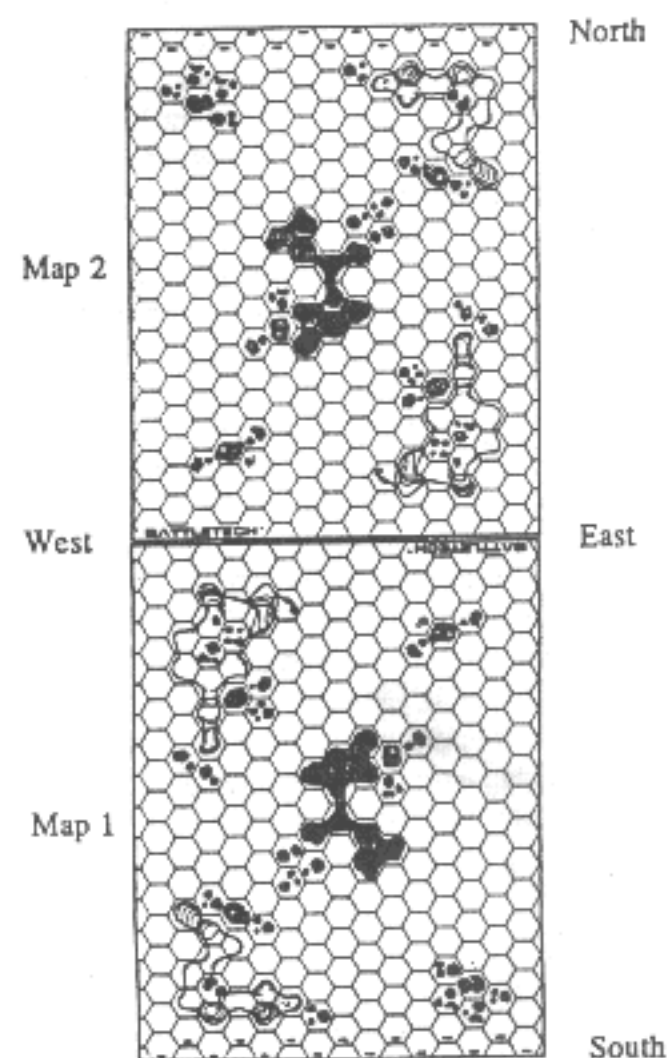

# BLOCKADE RUNNER

## RENDEZVOUS AT VERTHANDI

Excerpted from *StarPilot: Stories of Combat*, by Regin Fitzroy, Avalon Popular Press, 3031.

"What the hell is that thing?" Lieutenant Kestrel Syrnan had spent much of his life shepherding a diverse assortment of hulls from world to world in service to Kurita, but he was not sure he could trust his eyes now. The vessel his fighter was closing with looked like an old and battered *Union*, and certainly his IR scans and radar profiles agreed with that assessment. And yet...

"I'm reading normal scan, Lieutenant." The voice of Pilot Smetnov, Syrnan's wingman, was a little too high-pitched, betraying the boy's nervousness on this, his first patrol contact. "Radar profile and computer ID make her to be a *Union* Class, 3500 tons. She *could* be one of ours..."

"I know what the computer says, Pilot," Syrnan replied. "But she just doesn't feel right, somehow..."

He looked hard at the dull, rust-streaked, spherical hull. Curious... he couldn't see the stubby snouts of the PPCs normally mounted on a *Union's* bow and sides. For that matter, where were the port and starboard autocannons?

Cold realization snapped in Syrnan's mind. "Smetnov! Overthrust! Punch it!" White light poured from the fighter's boosters, slamming Syrnan hard into his seat at 4 Gs. Laser fire arced between the DropShip and Pilot Smetnov's *Shilone*, carving a ragged black slash along the fighter's port flank and spewing a cloud of glittering metal fragments. Missiles flared from the intruder's side, trailing white fire.

"Emergency! Emergency!" His fingers jabbed at the com channel settings. "Flight one-niner to base ship! Intruder is hostile. Repeat hostile! Intruder now changing course to zero-zero-three mark fiver, at two gees!"

A pair of missiles hit his craft amidships, sending him into an uncontrolled spin. Syrnan's last conscious thought was that the intruders were making a run for Verthandi. Of course, they would never make it.

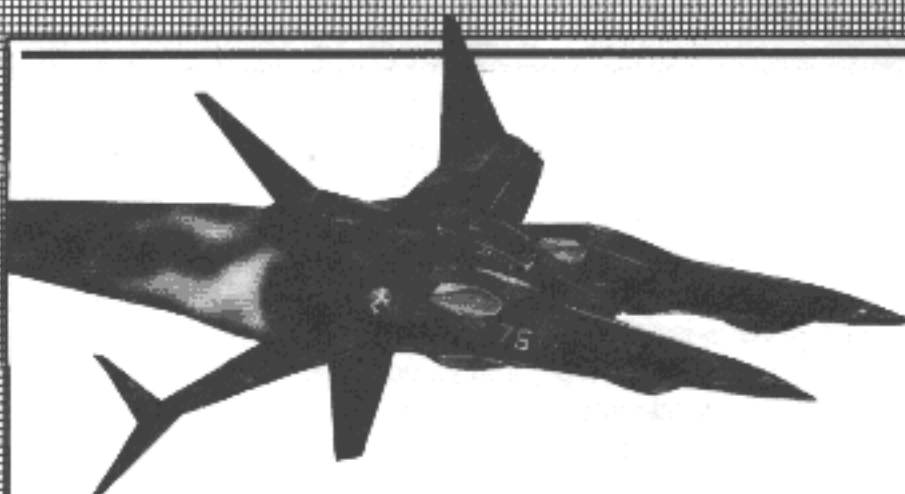

## GAME SET-UP

This scenario is played using **AeroTech** rules, map, and playing pieces. Fill out the record sheets for the DropShips and Fighters involved. Then deploy the ships.

### Attacker

The Attacker consists of the lone DropShip *Phobos*, with two *Chippewa* fighters on board. Outwardly, *Phobos* is similar to a *Union* Class DropShip. In fact, she is a converted freight-haul shell with the following stats:

<b>Thrust:</b>	3	<b>Armor:</b>	
<b>Overthrust:</b>	5	Nose	80
<b>Structural Integrity:</b>	7	Right Side	80
<b>Components</b>		Left Side	80
<b>Type</b>	<b>Tonnage</b>	Fuselage	120
6 Mech cocoons	900	Engine	40
4 doors	0	<b>Weapons:</b>	
2 AeroSpace Fighter cocoons	300	4 LRM-20 Racks	
100 people	1000	8 Medium Lasers	
Engines	630	1 Large Laser	
Fuel (6 thrust points/ton)	250	<b>Nose:</b>	
Bridge	24	2 LRM-20 Racks	
Weapons	53	2 Medium Lasers	
Armor	25	<b>Sides:</b>	
Heat Sinks	18	2 LRM-20 Racks	
Total	3200	2 Medium Lasers	
		1 Large Laser	
		<b>Rear Sides:</b>	
		2 Medium Lasers	
		<b>Aft:</b>	
		2 Medium Lasers	
		<b>Fire Factors</b>	
		Nose:	4
		Sides:	5
		Rear Sides:	1
		Aft:	1

The record sheet for a *Union* Class DropShip can be modified to reflect these changed stats.

*Phobos* is placed on any hex along the short end of the game map on the opposite side of the planet from the moon. At the beginning of the scenario, it has a velocity of six hexes/turn.

The Attacker begins the scenario with the initiative.

## SITUATION: NORN SYSTEM, 25 OCTOBER 3025 (TC)

**Defender**

The Defender is the blockading force of Admiral Kodo, and consists of the following:

- 1 *Leopard* Class DropShip grounded on Verthandi's inner moon, plus:
  - 1 SL-17 *Shilone* fighter grounded on moon
  - 1 SL-17 *Shilone* fighter within two hexes of moon
- 1 *Leopard* Class DropShip five hexes from the planet, plus:
  - 2 SL-17 *Shilone* fighters within two hexes of DropShip
  - 2 SL-15 *Slayer* fighters grounded on the planet
  - 2 SL-15 *Slayer* fighters within two hexes of the planet

The Defender may determine the facing, exact position, and velocity of each offplanet Kurita ship.

**Victory Conditions**

The Defender wins by destroying or capturing the DropShip *Phobos*, or otherwise preventing the vessel from landing safely on the planet.

The Attacker wins by safely landing the DropShip on the planet. A crash-landing is successful if the 'Mechs aboard are not damaged, partly successful if one or more 'Mechs are damaged, and a failure if three or more 'Mechs are destroyed.

**Special Rules**

As the *Phobos* approaches the planet Verthandi, the blockading vessels are not at first aware that the intruder is manned by mercenaries in the pay of rebel forces. The *Phobos* closely resembles a *Union* Class DropShip both visually and through radar and IR profile scans, and the jump freighter *Invidious* assisted the deception by transmitting IFF transponder codes that disguised the ship's origin.

As the scenario begins, it is the job of either the two *Shilone* fighters within two hexes of the *Leopard* Class DropShip or the two *Slayer* fighters within two hexes of the planet—whichever is closest to the Attacker—to investigate the incoming (apparently *Union* Class) DropShip. Once each turn before the Defender's Movement Phase, the Defender rolls 2D6. On a roll of 9 or less, the Defender will notice nothing unusual about the approaching *Union* DropShip. Two fighters (the *Slayers* or the *Shilones* on or near Verthandi) will be detailed to rendezvous with the visitor and to escort it to Verthandi's moon, where it can be checked and cleared by Combine officials at the naval base there.

When the Defender rolls a 10+, he will become suspicious of the intruder's course, signals, or intent. He may not launch grounded fighters or DropShips, nor may he deliberately approach or follow the *Phobos* with his spaceborne DropShip until his forces do have reason to be suspicious of the incoming vessel.

*Phobos* will be ordered on Turn 1 to proceed directly to Verthandi's moon for inspection, and to come no closer than ten hexes to the planet. The Defender will also become suspicious immediately if these instructions are not obeyed to his satisfaction. The two fighters chosen by the Defender to accompany *Phobos* to the moon base may begin maneuvering to rendezvous with the DropShip on Turn 1.

At any time the Attacker chooses, the *Phobos* may deviate from the Defender's orders, launch fighters, or open fire on the Defender's ships. At that time, of course, the Defender becomes suspicious, and may maneuver and fire freely.

To win this scenario, the Defender must maneuver his forces in such a way that he can quickly reinforce the escorting fighters when the intruder's true colors are shown.

The Attacker must choose carefully the moment at which he breaks for the planet, using all his skill to elude his escort and to enter Verthandi's atmosphere before the enemy can muster overwhelming firepower.

The first mercenary contract accepted by the fledgling Gray Death was a rough one—a contract that no experienced Merc unit would have been willing to take on. Rebellion had broken out in the Norn System in Kurita space. Norn II, a world called Verthandi, had been struggling for several years against their Kurita masters.

Verthandi was a planet poor in natural resources but rich in culture, art, and history. Its population's long tradition of freethinking independence brought it trouble when full-scale revolt broke out in mid-3023. Though not closely tied to the Draconis Combine, the Norn system was part of a fief belonging to Hassid Alexander Ricol, Kurita's Red Duke, and so could not be permitted to raise the banner of revolt.

The rebellion seemed doomed. No veteran Merc company would sign on with a cause that was certain to fail—not when failure meant being stranded on a world occupied by the notoriously unforgiving legions of Kurita.

The Gray Death took the contract because no one else would consider hiring a half-strength company with little experience and no rep. Besides, this was an opportunity for Grayson Carlyle to strike back at House Kurita and the minor lord responsible for the death of his father on Trell I.

To fulfill their contract, the Gray Death had to reach Norn II. Carlyle's was the rare mercenary unit with its own JumpShip, which freed it from having to rely for transportation on its employers. The former free-trader *Invidious* dropped into Norn's north polar jump point only long enough to recharge her drives and to release a single DropShip. That DropShip, a converted freight hauler similar in lines and mass to a conventional *Union* Class, accelerated for the second of Norn's three worlds.

It was a calculated risk. The DropShip *Phobos* might look like a *Union* Class, but she was lightly armed. Her in-hull weaponry had been added to an unarmed freight-haul shell, and she carried only six 'Mechs and a pair of *Chippewa* AeroSpace Fighters.

Ahead lay a powerful air blockade that Kurita had thrown around Verthandi while its ground forces smashed the planet into submission.

# FIRST MISSION

## DARING RESCUE

Excerpted from *Echoes of the Past*, by Janice Taylor, Kalinga House Press, 3032.

There was a time, they say, when slavery was outlawed. Well, maybe that was true somewhere, sometime. Humans being what they are, though, that culture and its laws must have been a brief flash in the age-long night that has engulfed human history.

That's right. I'm a historian, not a warrior. For me, the Succession Wars were an historical event, the death throes of yet another human civilization that had already lasted for centuries, and showed no signs of dying out for centuries more. I had nothing to do with politics. Politics, I thought, involved current events, history in the making, and I found the ancient stories of Man's diaspora far more interesting than those of his current disintegration. But the day the Kurita forces moved in to crush the rebellion in Regis, Verthandi's capital, I changed my point of view.

Have you ever seen a city become its own funeral pyre lighting up the night sky? Here was the literal, living fabric of history, a footnote some future scholar would read in his own survey of Man's past...assuming Man survived to see that history written.

The local Kurita commander—Colonel Nagumo, I think his name was—had decided that the University at Regis represented a potential trouble spot and had moved swiftly to eliminate it. The rebellion had been nearly crushed by that time, but Nagumo wanted to be sure. That meant that the intellectuals, the doctors and teachers, the students, the bright young people with freethinking traditions, yes, even the historians—they all had to go.

Most of the older men and women were shot on the spot. The young men, those who could work, were sorted out, chained together, and marched from the city while they were still rounding up the rest of us in the ruin of the Regis sports arena. I was among a group of maybe 50 younger women being prodded into a ragged, dirty line in the shadow of a pair of 'Mechs, which, to our uneducated eyes, loomed taller than mountains against the sun. Black-uniformed Kurita soldiers tied our hands behind our backs and yoked our necks together with meter-long rope leads, then someone barked a command and we started trudging toward the north. (Continued on p. 27, column 1)

### GAME SET-UP

Lay out the two **BattleTech** maps in the configuration shown. Water hexes are treated as Light Woods. It is assumed that the terrain to the east and west are low ridges and Heavy Woods, obscuring line-of-sight.

This scenario should be played using **Expert BattleTech** rules. The Defender deploys first.

#### Defender

The Defending force consists of one House Kurita Light Recon Lance. All 'Mechs are in good condition:

- 2 *Phoenix Hawks*
- 1 *Wasp*
- 1 *Stinger*

#### Deployment

The Defender places his 'Mechs in any desired position, moving north on Map 1. Fifteen counters (blank cardboard game counters or similar markers of any type) are placed on Map 1 south of Hex 0713. To distinguish them as Kurita's ground troops, five of these counters should be marked or of a different color than the other counters.

#### Attacker

Carlyle's forces consist of:

- Carlyle's *Shadow Hawk*
- Kalmar's *Locust*
- 2 *Stingers*

Ground or hovercraft armor totalling no more than 80 tons (optional; see **Special Rules** below)

The *Locust* carries damage as described in the BattleMech Status Reports. The *Shadow Hawk* is undamaged. The *Stingers* are part of the local rebel resistance. Both pilots have skills of *Piloting* 5, *Gunnery* 4. Both 'Mechs are undamaged.

#### Deployment

The Attacker secretly notes the hexes where each of his 'Mechs will first appear. These may be anywhere along the east or west border of either map. He may wait until the Defender has deployed in order to record these positions. Once play has begun, however, he may not change them.

#### Victory Conditions

The Attacker wins 1 Victory Point for each five liberated prisoners (represented by one counter). He also wins 5 points for destroying each enemy *Phoenix Hawk*, and 3 points for each other destroyed enemy 'Mech. He loses 3 points for each of his own 'Mechs destroyed, and 1 for each prisoner counter destroyed or exited off the north end of Map 2.

The Defender has his own set of Victory Points. He wins 5 points for destroying Carlyle's *Shadow Hawk*, and 3 points for each *Stinger*. He wins 2 points for each prisoner counter that is exited off the north edge of Map 2. He loses 1 point for each prisoner unit killed or rescued. The levels of victory are judged as follows:

VICTORY TABLE		
Attacker Victory Points	Defender Victory Points	Results
15 or more	10 or More	Spectacular Victory
10 - 14		Decisive Victory
5 - 9	5 - 9	Partial Victory
1 - 4	1 - 4	Marginal Victory
0 or less	0 or less	Utter defeat

Obviously, it is possible for both sides to claim a measure of victory during the same engagement.

## SITUATION: 1130 HOURS (ADJUSTED LOCAL TIME), 4 DECEMBER 3025 (TC)

### Special Rules

The Attacker automatically has the initiative in the first combat round. He may choose when to launch his attack. Units may exit off the east or west borders of the map, but may not return to the battle.

The counters designated as prisoner and ground force units move one hex per turn. They may not change levels by more than one per turn.

Each Kurita infantry counter represents four men. Each infantry unit may fire two SRMs each turn, with a maximum range of six hexes and a basic To-Hit Target of 5. These SRMs represent man-portable, shoulder-launched anti-armor missiles.

Any hit by any BattleMech weapon (including kicking or punching attacks) will pin an infantry or prisoner unit in place for the entire next combat turn. Pinned units may neither move nor fire. A pinned unit is destroyed by any hit from a BattleMech weapon. Pinned units may be identified by inverting them on the map.

Prisoner units may be moved by whichever player has units (Mechs or infantry) within one hex of them. Prisoner units adjacent to units of both sides or with no other units nearby may not move.

If they are available, players may agree to use the **CityTech** rules for infantry combat instead of those given here. If using **CityTech** rules, the Attacker may add ground or hovercraft armor units up to a total of 80 tons. (See the rule book for creating and using armored combat vehicles.) Balance this additional strength on the Attacker's side by allowing the Defender to add 10 *additional* ground troops to his forces.

One Mech may carry one counter of prisoners in its hands. Picking up prisoners takes 2 MP. It may not fire while carrying prisoners, nor may it take any action other than walking. Any arm or front torso damage suffered by the Mech will kill the prisoners it carries.

It is assumed that units moving off the north end of Map 2 come within range of the enemy DropShips, blocking Attacker maneuver in that direction.

The hostages must be rescued before the Defender gets them under the cover of his big guns.

### (Daring Rescue, Cont.)

Rumors had been flying since we'd been herded into the arena the night before. There was a ship, a big ground-to-JumpShip transport parked ten kilometers to the north of Regis. Now we knew! They were taking us offplanet—as slaves!

Slavery had never been more to me than an intellectual curiosity, of course. Now I was experiencing the concept firsthand—the empty, inner desolation, the feelings of complete and utter hopelessness, of humiliation, of black dread of a tomorrow beyond my control. I would have killed myself then and there had I not been bound and guarded and so numb with shock it was all I could do to put one foot in front of another.

At midday, our captors called a sudden halt. Something was happening, though we didn't know what. Then there was a flash off to our right, and a crack like a hard-slammed door. One of the girls screamed a warning to get down, and all of us huddled in the dirt as a pair of gleaming, towering machines strode from a nearby thicket, and the world turned raw with noise and a rain of dirt and metal fragments. We were being rescued!

We were also in imminent danger of being killed. I remember thinking that death in that shrieking, erupting hell was infinitely preferable to the horror that awaited us offworld. But I huddled in the dust just the same, trying to use my knees and shoulders to scrape a non-existent hole in which I could hide...and survive.

The Gray Death did not face an easy task on its first mission as a mercenary band.

Four of Kurita's BattleMech regiments were on Norm II under the command of Governor-General Nagumo, together with at least eight regiments of infantry and conventional armor. At the time of the Verthandi Campaign, the Gray Death was little more than two lances and a handful of support troops and Techs, too few to challenge Nagumo's regiments openly. However, Carlyle enjoyed the advantages valued by guerrilla and resistance leaders throughout history: he had the support of the people, and his opponent's forces were tied down garrisoning cities, fortresses, and key industrial, communications, and transport facilities.

Carlyle waged a skillful war against Verthandi's Kurita overlords. The most critical aspect of his campaign was to hold the respect and love of the native Verthandians. On several occasions, Carlyle passed up tempting targets of supplies, fuel, or ammunition to instead break open prison camps, eliminate city garrisons, or liberate bands of slaves bound for Combine mines, factories, or military brothels. The situation depicted here represents one of Carlyle's snap raids to liberate a band of prisoners being escorted to a Combine freighter's grounded DropShip.

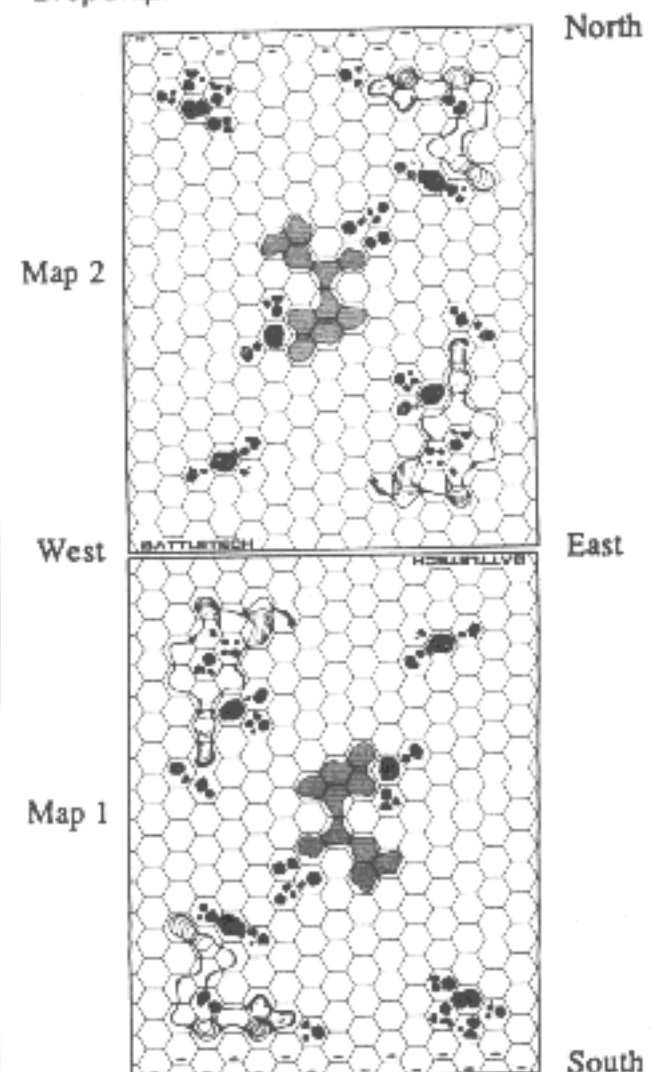

# NAGUMO'S TRAP

## DAWN RAID

Excerpted from *Recollections of the Verthandian Rebellion*, by Vertix Sonovarro and Mikhail Zhang, Kalinga House Press, 3030.

We needed supplies and equipment, it was as simple as that. The rebellion on Verthandi had been going wrong for so long... It was now something of a shock to find ourselves able to reach out and take what we needed from the Blackjackets to conduct a halfway decent military campaign instead of scrabbling in the swamps just to stay alive.

We had the Gray Death to thank for that, of course. Those mercenaries that the rebel council had hired on Galatea... well... not many of us thought they'd amount to much. I mean, what could we do with a couple of 'Mech lances, squared off against eight or ten regiments of Kurita's best? As my father used to say, them ain't gambling odds... they's suicide! But Grayson Carlyle proved us wrong.

His group had been on Verthandi for a couple of local years. Their early raids had made the Kurita forces so cautious that they'd stopped coming out into the hills to look for us. It had even reached the point where they didn't look too hard on their daily sweep-and-search simply because there was too big a chance they might actually *find* us. Our 'Mech force had grown with a couple of lucky captures and some defections from the Loyalist bastards. Now, Captain Carlyle allowed as how it was time to go pick up some spare parts to keep us going.

A local farmer reported the Blackjacket supply dump. Carlyle had some of our scouts watch it for a day or two, to make sure it wasn't a trap. There was the usual traffic, garrison ground haulers and hovercraft slipping in and out to pick up requisitions, occasional enemy 'Mechs checking in for servicing or maintenance work, but nothing out of the ordinary. Carlyle and the rebel council made the final decision. We would hit the supply dump at dawn the next day.

We had it all our own way at first. Checka burst out of the woods first, hosing the guards and machine gun towers with a long, rolling stream of fire from his *Stinger's* two machine guns. Captain Carlyle's *Shadow Hawk* and Clay's battered *Wolverine* came next, lumbering toward the supply dump while  
(Continued on p. 29, column 2)

## GAME SET-UP

If the players have **CityTech**, lay out two **BattleTech** game maps and one **CityTech** gameboard as shown. The paved area on the **CityTech** mapboard represents the fenced-in supply dump area. If **CityTech** is not available, simply push the two **BattleTech** maps together with the same orientation to one another. Mark the supply dump with counters or other tokens in the area between Hexes 1507 and 1511 on the West Map, and 0307 and 0311 on the East Map.

Water hexes are considered to be swamp in this scenario. BattleMechs that enter these areas will become mired in the mud and unable to move.

Place a number of cardboard counters or other small tokens within the supply dump area to represent crates of ammunition and other supplies needed by the rebel forces.

The Defender sets up first. The Attacker has the initiative.

### Defender

The Free Verthandian Rangers is a light BattleMech raiding unit consisting of the following:

Elements of the Gray Death Command Lance:

- 1 *Shadow Hawk* (Captain Grayson Carlyle)
- 1 *Wolverine* (Delmar Clay)
- 1 *Rifleman* (Davis McCall)

Elements of the Free Verthandian Rangers:

- 1 *Phoenix Hawk* (Dace)
- 1 *Stinger* (Cheka)
- 1 *Wasp* (Sonovarro)
- 1 *Locust* (Traxen)

The Gray Death 'Mechs have the damage described for each in the BattleMech Status reports. The Verthandian 'Mechs are in good condition.

The Defender may set up his 'Mechs anywhere on the East and/or West mapboards. None may be closer than eight hexes to the nearest supply dump hex.

### Attacker

The attacking force consists of twelve Kurita BattleMechs of Company A, Third Strike Regiment, assigned to garrison and suppression duty on Verthandi. It consists of the following:

Command Lance

- 1 *Warhammer*
- 1 *Marauder*
- 1 *Archer*
- 1 *Wasp* (Medium Laser inoperable)

Fire Lance

- 1 *Crusader* (8 Heat Sinks; Center Torso armor at 17)
- 3 *Archers*

Recon Lance

- 1 *Griffin* (+2 to all *Piloting* rolls due to gyro malfunction)
- 1 *Phoenix Hawk*
- 1 *Stinger* (8 Heat Sinks)
- 1 *Wasp*

The Attacker secretly notes which hexes his 'Mechs will enter. These entry hexes may be on any map, and entered from any map edge. The area off the map is considered to be heavy woods and swamp, which block all line-of-sight. The Attacker must bring at least his Fire Lance onto the board on Turn 1. The other lances may remain off the board, entering on any turn of the Attacker's choosing. Individual 'Mechs may enter on different turns.

## SITUATION: FIRST TENTH, LOCAL DAWN, 20 AUGUST 3026 (TC)

### Victory Conditions

The Attacker scores 10 points for every rebel BattleMech destroyed or captured, and loses 5 points for every one of his own 'Mechs lost. The destruction or capture of the Gray Death's leader is worth 25 points.

The Attacker can assess his victory on the Victory Table below.

The Defender scores 10 points for every enemy BattleMech destroyed, 15 points for every enemy 'Mech captured, and *loses* 10 points for every one of his own machines lost. If Carlyle is killed or captured, the Defender loses 25 points, and the future of the rebel cause begins to look very black, indeed. The Defender also wins 5 points for each supply counter removed from the map, and 10 points for every one of his own 'Mechs that successfully exits the map *on the same map edge as the majority of other friendly 'Mechs.* (See **Special Rules**, below.)

Use the Victory Table to judge the success or failure of either side:

VICTORY TABLE	
Victory Points	Results
50+	Spectacular Victory
25 - 49	Major Victory
10 - 24	Marginal Victory
0 - 10	We'll call it a victory anyway
Less than 0	Utter Defeat

It is possible for both sides to disengage from the battle and claim victory. By and large, the Attacker wins if he destroys the rebel force, and the Defender wins if he escapes destruction. Note that the Attacker forces can more easily stand the loss of BattleMechs than the rebel forces.

### Special Rules

**Withdrawal:** The Defender must attempt to prevent his force from becoming scattered in the surrounding swamps. While 'Mechs exiting the map are not counted as destroyed (some may be hunted down, but the majority will return to the rebel camp in a few days), extra Victory Points are only awarded for 'Mechs that exit from the same edge of a map as the rest of their comrades. The number of Defender 'Mechs exiting from each map edge are recorded; the largest number is multiplied by 10 to give the Victory Point total for exiting 'Mechs from the board. The rest do not count toward the Defender's Victory Point totals.

**Supplies:** The purpose of the raid is to capture ammunition, tools, spare parts, and other needed supplies. The counters placed in the supply dump area represent crates of such supplies. Each 'Mech with hands (NOT *Locusts* or *Riflemen*) may carry one counter for each free hand available. Picking up one crate of supplies costs 2 MP. Note that some 'Mechs (*Wasps* and *Stingers*) carry weapons with their hands, and must either store the weapon to free both hands, or carry only one crate.

**Skills:** The skills of the Gray Death pilots are listed elsewhere. The Verthandian pilots all have *Piloting* 5, *Gunnery* 4. The Kurita pilots all have *Piloting* 4, *Gunnery* 4.

### Optional Special Rule

Players with access to FASA's **AeroTech** may wish to substitute an Air Lance for the Kurita Recon Lance. This will consist of four SL-21 *Sholagar* fighters, each armed with an SRM 4 and two medium lasers. The fighters may not appear over the combat area before Turn 8.

Aerospace Fighters shot down by the Defender are worth 15 Victory Points each. (Their destruction will give the rebels an extra boost.) Introduction of this special rule will demonstrate to all concerned what control of the air means in guerrilla warfare.

A rebel raid for supplies, ammunition, and spare 'Mech parts was decoyed into a trap set by General Nagumo in the Southern Highland region of Verthandi. Though three of the rebel 'Mechs were piloted by experienced MechWarriors of the Gray Death mercenary unit, including Grayson Carlyle himself, most of the pilots were raw and relatively untrained.

Nagumo's trap involved planting a supply dump in an area near where rebel activity had been particularly heavy, ringing the area with a full company of 'Mechs carefully camouflaged and shielded. Pilots from the supply base barracks stood rotation duty shifts for hours at a time, trekking far out into the brush and swamps to reach their hidden 'Mechs.

Their patience was rewarded with the approach of Carlyle's hunting column. According to plan, the ambushers waited until the raiders launched their attack, and an observer within the supply dump radioed a command. Then twelve 'Mechs closed in from every side, their prey trapped between them.

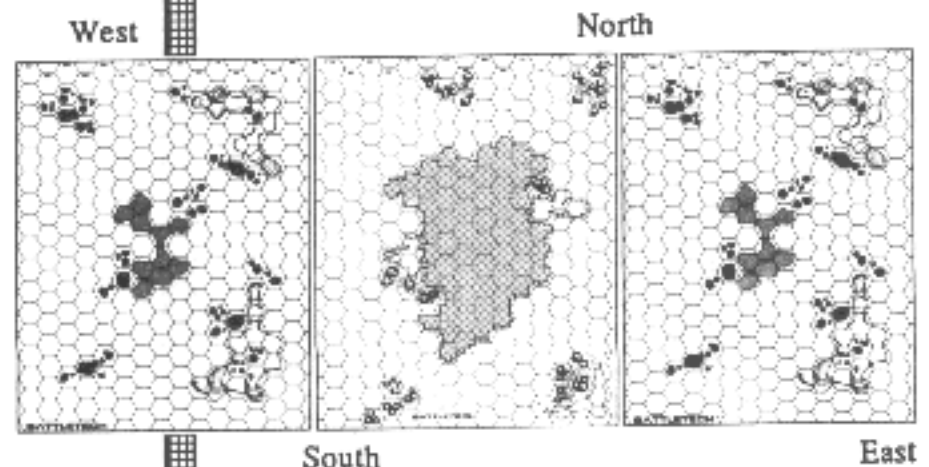

### (Dawn Raid, Cont.)

McCall's *Rifleman* took up a position to sweep the far woods if necessary. The other rebel machines, my *Wasp*, Dace's *Phoenix Hawk*, and Traxen's *Locust* advanced cautiously into the open. The field was ours.

The Captain hadn't made it halfway to the supply dump when the missiles struck. For one horrid instant, we couldn't tell where they were coming from, and the rebel forces wavered, threatening to break and run.

"Hold fast!" we heard Carlyle bellowing over the com phones. "Hold fast, dammit, or I'll shoot you myself!"

At that moment, it's possible some of us might have risked being shot by Carlyle, for just then we saw the first of the enemy *Archers* smashing out of the woods to the south. It was a trap!



# THIRST FOR VENGEANCE

## LAND IN RUINS

Excerpted from *'Mechs of Flesh and Blood*, by Lori Kalmar, Avalon Press, 3045.

There was an unnatural stillness in the air, an oppressiveness that permeated even our 'Mech cockpits, pressing in upon us and crushing our spirits. Spreading out from the roiling columns of destruction over what had been our home, a pall of turgid black smoke hung low across the sky.

There was a low, agonized moan on the comcircuit. Who? Koga? McCall? I couldn't be sure.

"Clear the circuits," Carlyle said. The bitterness and shock were sharp behind his words.

I set up a high-mag scan, anything to occupy hands and mind gone numb. There was something...

"Captain," I said. "Movement at 3200, bearing 095."

"I see it, Lori. They're still here."

Machines moved in the rubble, searching for loot, perhaps... or for survivors. I counted eight, though there could have been more beyond the smoke and the wreckage. I saw a *Phoenix Hawk* mindlessly kicking at a fragment of ferrocrete wall still standing as high as the 'Mech's knee. Beyond, a *Griffin* had stooped enough that its vast, armored hands could paw through the ruin of what had been the astech barracks. As I snapped my *Hawk's* targeting locator from 'Mech to 'Mech, it became obvious that most of the machines in our base were lights, *Stingers* and *Wasps* and a couple of *Phoenix Hawks*. Easy pickings.

"We'll take them," Carlyle said, his words more like a growl that penetrated even the electronic barriers of the battlecom circuit with their pain.

Silently, we maneuvered into position.

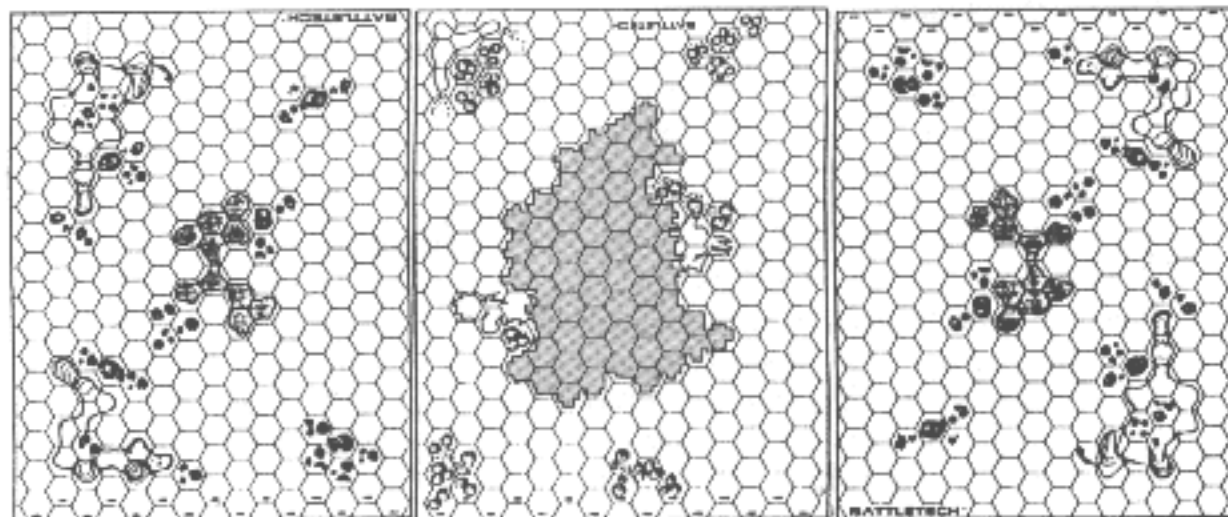
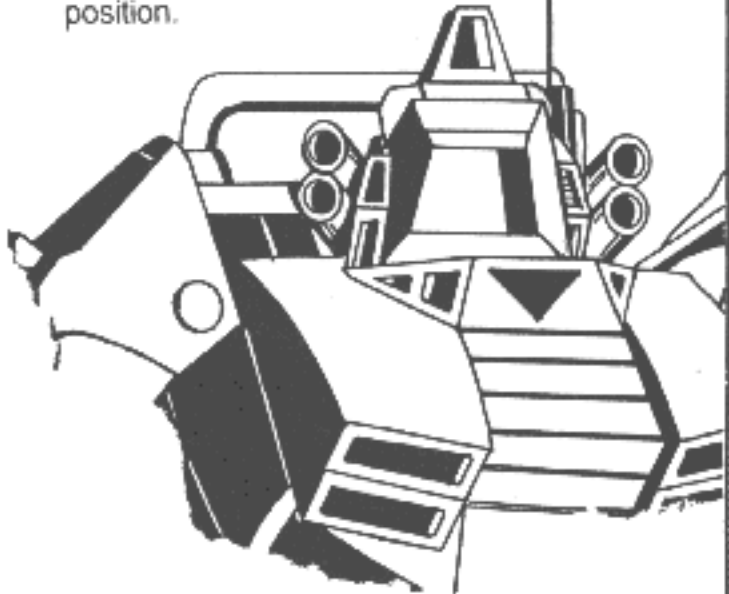

### GAME SET-UP

Lay out the **BattleTech** maps and one **City Tech** mapboard as shown. The paved area on the **CityTech** map should be covered with building counters, with about three-quarters of those buildings ruined.

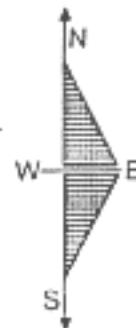

### Attacker

The Attacker is elements of the Gray Death Legion, recently returned to their baseworld of Helm to find their colony destroyed.

#### Command Lance

Carlyle's *Marauder*  
Kalmar's *Shadow Hawk*  
Clay's *Wolverine*  
McCall's *Rifleman*

#### Fire Lance

Khaled's *Warhammer*  
Koga's *Archer*  
Sharyl's *Shadow Hawk*  
Bear's *Crusader*

These 'Mechs carry the damage listed for each in their BattleMech Status Reports.

### Deployment

The Attacker may enter from any edge of the West Map, from the north, south, or west of the combat area.

### Defender

The Defender's forces are elements of House Marik's 5th Light BattleMech Guards of the Hammerstrike Company. They consist of the following:

#### Fire Lance

1 *Rifleman* (Center Torso, 16 Armor Points)  
1 *Phoenix Hawk*  
1 *Phoenix Hawk* (Heavy Laser creates 4 extra Heat Points)  
1 *Stinger*

#### Recon Lance

1 *Griffin* (Left Arm, 9 Armor Points)  
1 *Wasp* (SRM 2 out of ammo)  
2 *Stingers*

### Deployment

The Defender deploys first anywhere within ten hexes of any paved city hex, or within the city itself. No 'Mechs may be deployed on the East mapboard. The Defender sets up first.

## SITUATION: HELM, LATE AFTERNOON, LOCAL TIME, 24 MARCH 3028 (TC)

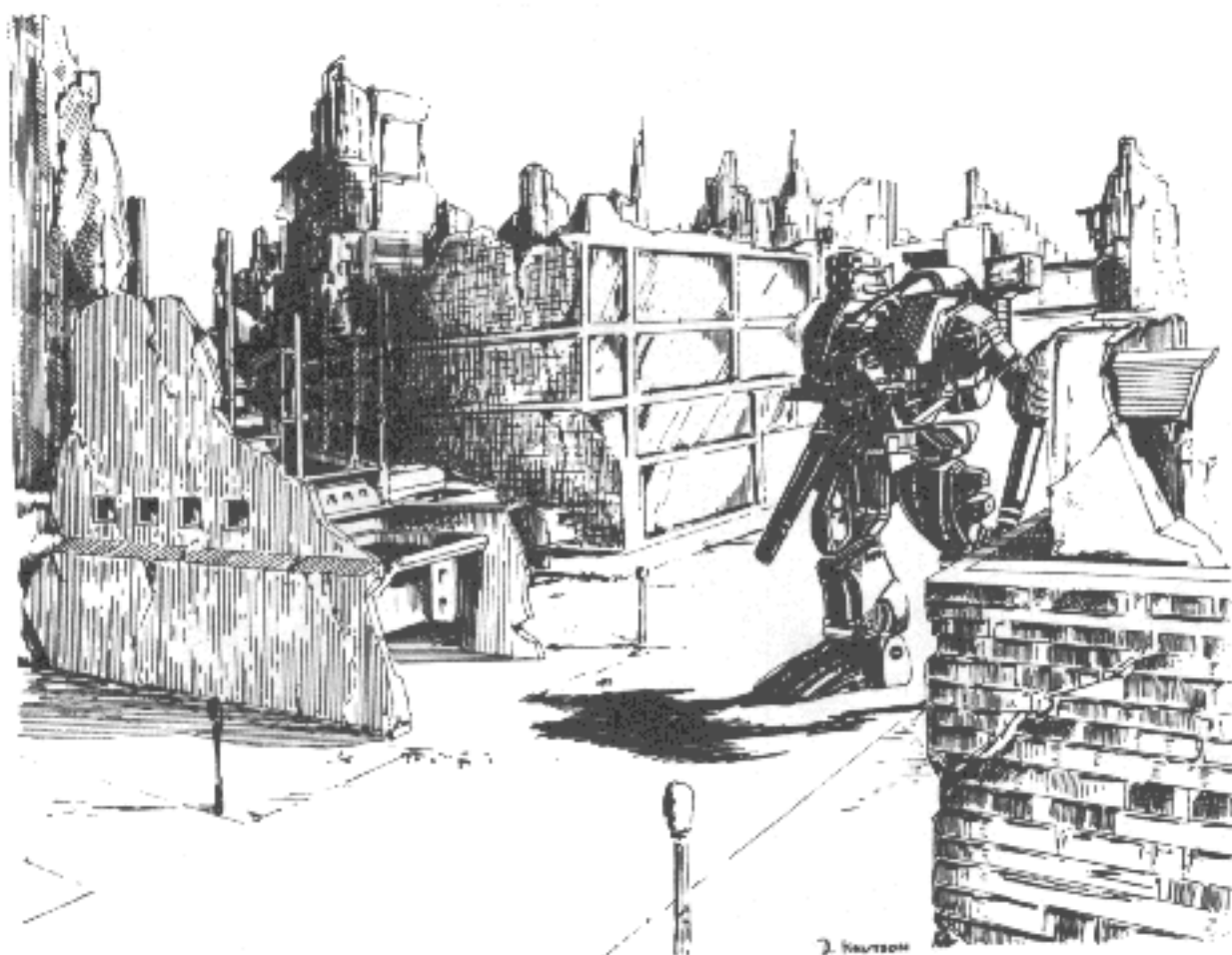

### Victory Conditions

The Defender wins by withdrawing his 'Mechs off the east edge of the map. His success is judged according to the following Victory Table:

'Mechs Withdrawn	VICTORY TABLE Results
7-8	Decisive Victory
5-6	Major Victory
4-5	Rough out there, wasn't it?
2-3	War is hell
0-1	Utter Defeat

The Attacker wins by destroying, crippling, or capturing all enemy 'Mechs. The Attacker's home base has just been destroyed. Anything less than annihilation of the enemy force will make the victory seem incomplete.

For Victory Point purposes, defender units that exit the map to the north, south, or west are considered destroyed. The area is heavy jungle, and so the rampaging Gray Death units should be able to pick off most stragglers in short order. To the east lies the Light Guard's base, offering relative—and temporary—safety.

### Optional Special Rules

The players may try the same scenario, but exclude the Gray Death's Fire Lance from the order of battle. This will make the contest more evenly balanced. Victory goes to the side that remains on the field at the end of the battle, with retreat allowed off any map edge.

If both sides agree, both the Attacker and Defender may add ground or hovercraft armor to their orders of battle, up to a total of 150 tons. Rules for building and using armor are given in **CityTech**. Defender armor units do not count toward victory conditions, but can be used to delay or blunt the Attacker's moves, buying the Defender more time.

After the highly successful campaign against House Liao, the combat elements of the Gray Death returned to Helm, their home base planet, to find Marik 'Mechs in control of the planet, and their colony in ruins. A plot within the Marik high command had succeeded in discrediting the Gray Death by blaming them for atrocities against House Liao, and elements of the 5th Light Guards and the 12th White Saber Legion had been dispatched to secure the mercenary unit's base on Helm while the matter was "being investigated".

Carlyle's returning combat lances avoided Marik orbital and deep-space patrols, and landed near the ruin of their holdfast. They found the city levelled, their homes laid waste, the unit's noncombatant wives, husbands, friends, and children killed, scattered, or marched off to an uncertain future.

There are times in warfare when a berserker rage that asks and grants no quarter takes over even the most trained and disciplined of military units. This was one of those times.

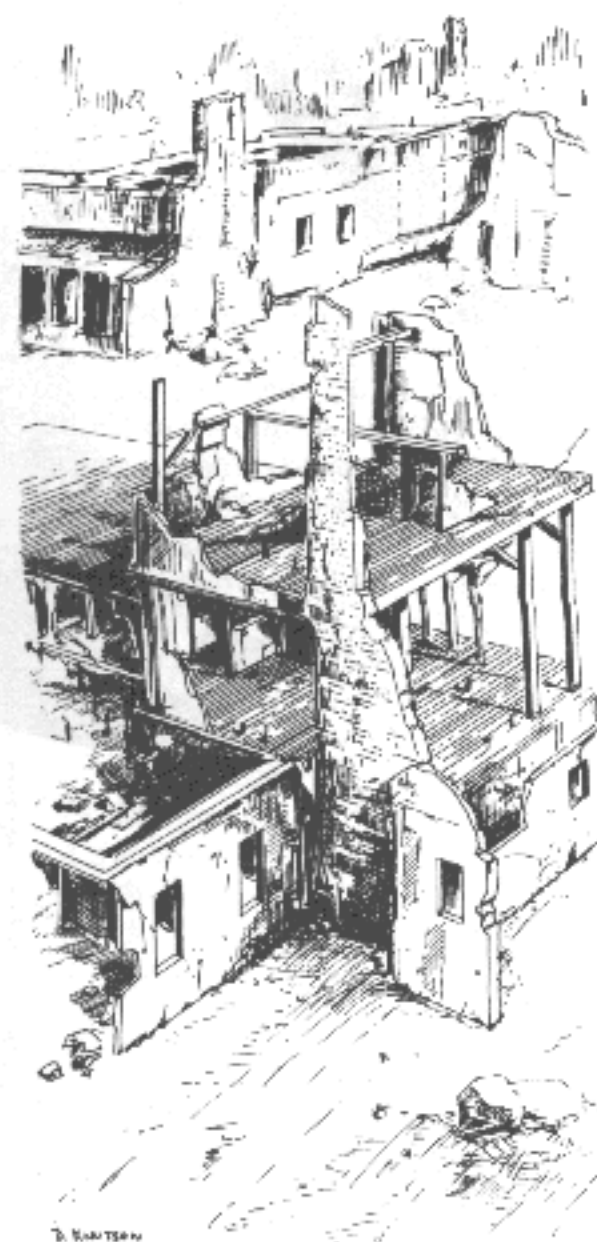

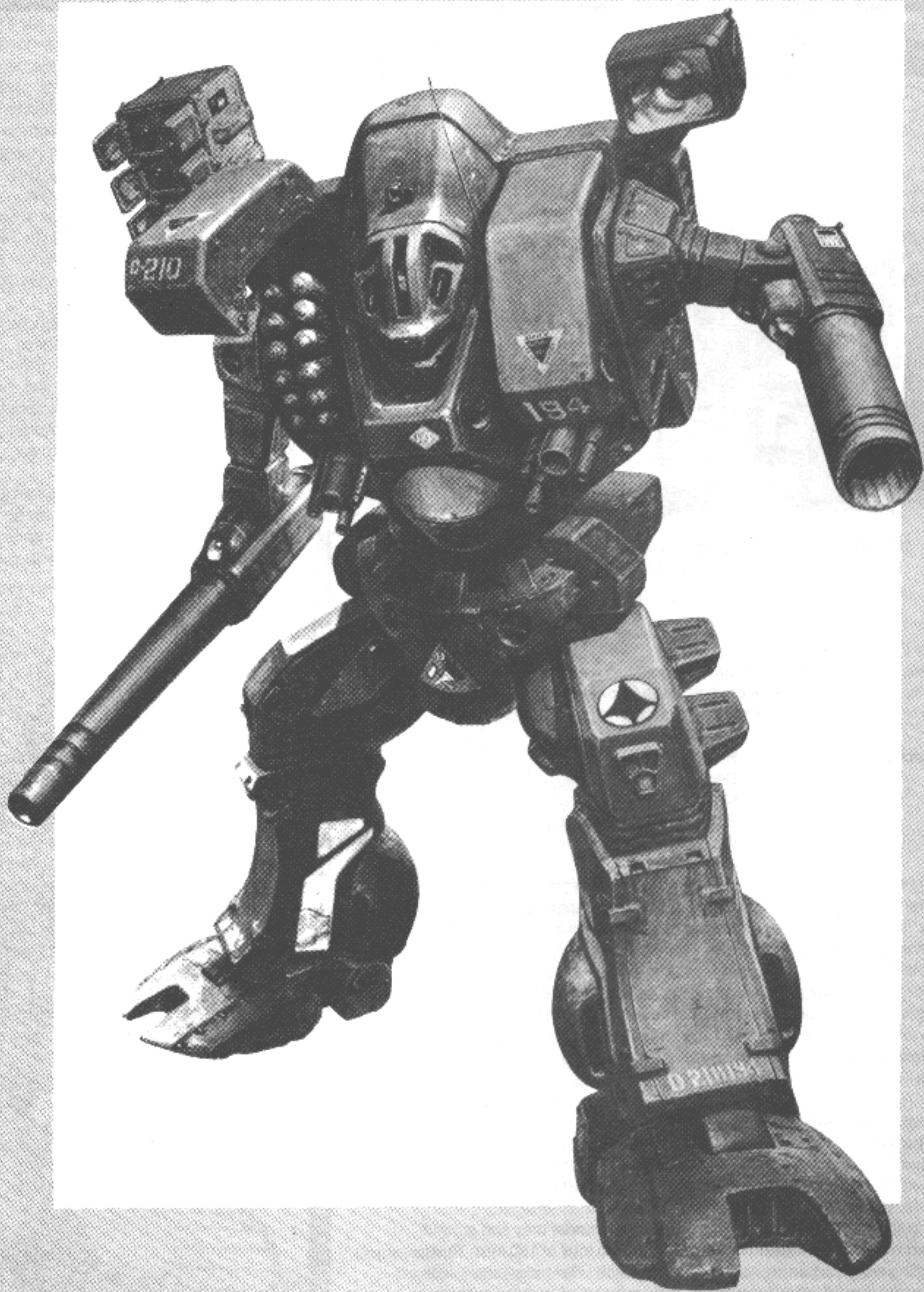

# BETRAYAL AT HELM

Excerpted from *'Mechs of Flesh and Blood*, by Lori Kalmar, Avalon Press, 3045.

Once we discovered that ancient Star League storehouse, we understood why the Marik generals had betrayed us. There were enough arms and parts and 'Mechs there to arm and equip a regiment—even ten regiments—all in perfect condition, having waited silently in that darkness for the better part of a thousand years. Our DropShips were at the field we had cleared nearby, long lines of treasure already vanishing into their cavernous holds.

There was a new note of urgency now. The scouts Captain Carlyle had thrown out to the north and east reported the approach of Kleider's army. We knew those forces included Marik's 5th and 7th Light Assault Groups and probably what was left of the 12th White Saber Legion. They were coming down through the mountains by way of Drango, Lee's Pass, and the Vermillion River Valley, and it looked like we couldn't do a bloody thing to stop them.

The Captain had been giving the matter a lot of thought, though. He'd spent most of the night before in the HQ tent, going over the satellite maps and recon plots. When we met again at dawn, he was smiling for the first time in a long time.



## SITUATION: MID-MORNING LOCAL TIME, 1 APRIL 3028 (TC)

The Gray Death had to evacuate Helm while three Marik regiments closed in for the kill. The evacuation was complicated by the discovery of an enormous stockpile of Star League weapons and equipment buried in a long-forgotten storehouse within a mountain. It was this treasure trove of equipment, Carlyle deduced, that had brought about the betrayal of the Gray Death by House Marik officers. If Janos Marik could secure those weapons, the Free Worlds League might emerge as the mightiest power among the Successor States. To get them, Marik's generals plotted to discredit the Gray Death, framing them for a heinous crime, then launching an attack bent on annihilating the unit.

Grayson Carlyle did not sit and wait for that to happen, however. The key to defending his grounded DropShips was the fact that the enemy was approaching through three high passes. Though the passes were not directly connected, Carlyle's scouts had discovered a network of trails and underground passageways joining them, which would allow a single small defensive force to move back and forth between, striking the attacking forces in rapid succession.

In the following campaign, the first three scenarios describe the actions in each of the mountain passes. The fourth is a final battle against the surviving, united attackers. Obviously, the better the Defender does against the attacking armies when they are divided, the better his chances when he squares off against the survivors on the Vermillion Plains.

### Victory Points

Victory in each of the following scenarios is determined by adding up points for the various Marik BattleMechs:

<i>Warhammer</i>	10
<i>Archer</i>	10
<i>Thunderbolt</i>	9
<i>Crusader</i>	9
<i>Rifleman</i>	8
<i>Shadow Hawk</i>	7
<i>Griffin</i>	7
<i>Wolverine</i>	7
<i>Phoenix Hawk</i>	5
<i>Stinger</i>	3
<i>Wasp</i>	3

In each scenario, ground armor or hovercraft are not counted toward Victory Points, but are useful for delaying the enemy or inflicting additional losses on his forces.

# SCENARIO 1

## DRANGO PASS

Excerpted from *Warrior's Song*, by Henik Acheon, Marika Press, 3032.

All morning long it had been "c'mon, men, press up! Close it up!" Old Maranov really had us hump to reach this little burg out in the middle of nowhere, a mountain village called Drango on the maps. The Colonel, it seemed, wanted us through and on the Vermillion Plains in a very bad way.

Of course, all the older hands saw it coming. There we were in this mountain pass, two, maybe three thousand meters' altitude, with the mountain peaks on either side of us like the spikes of glistening white teeth. There was no way to go, except back the way we'd come...or straight ahead. And we knew the Grey Death was waiting for us that way.

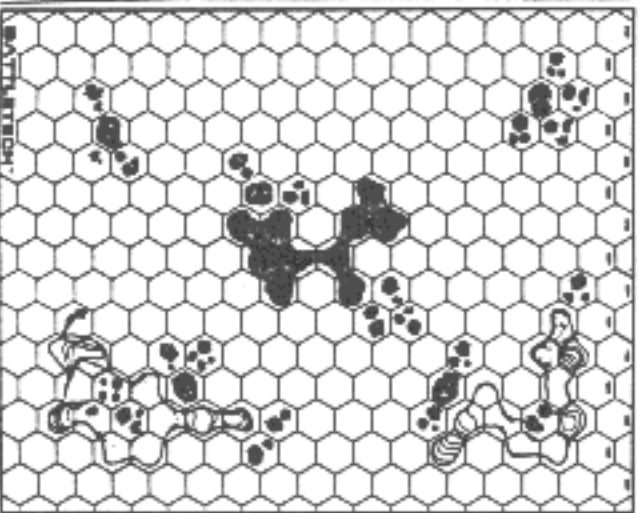
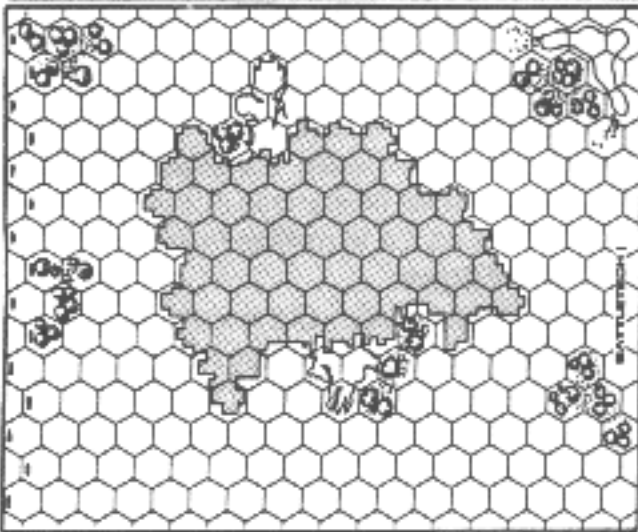
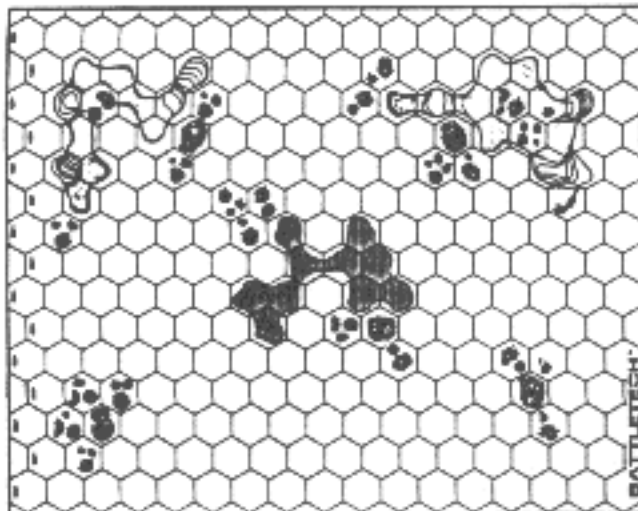

### GAME SET-UP

Lay out the two **BattleTech** game maps and one **CityTech** mapboard as shown. **CityTech** building counters can be placed in and around the paved city area. The mapped region represents Drango Gap and a small, deserted settlement in the pass named Drango.

All Water hexes are considered to be open terrain.

#### Defender

The Gray Death Command and Fire Lances, plus ground units from the Helmhold Castle garrison:

##### Command Lance

- Carlyle's *Marauder*
- Kalmar's *Shadow Hawk*
- Clay's *Wolverine*
- McCall's *Rifleman*

##### Fire Lance

- Khaled's *Warhammer*
- Koga's *Archer*
- Sharyl's *Shadow Hawk*
- Bear's *Crusader*

##### Ground Units

- Hover armor totalling no more than 150 tons
- Foot and/or Mechanized Infantry totalling no more than 100 tons

#### Deployment

The Gray Death may deploy anywhere on any of the three mapboards, or they may deploy off the **CityTech** mapboard at Hex 0301 or 1217. These hexes represent the openings to narrow clefts through the surrounding canyon walls, leading to the other valleys. 'Mechs deployed in these off-map passageways may enter on any turn, but can only enter the map one at a time, one per turn for each opening used. The Defender has the initiative.

#### Attacker

The Attacker represents a company of House Marik's 4th Light Assault Group, plus ground units of the Marik House Guard. It includes:

##### Command Lance

- 1 *Warhammer* (Add 1 extra Heat Point per Right PPC shot)
- 2 *Phoenix Hawks*
- 1 *Stinger*

##### Fire Lance

- 1 *Griffin*
- 1 *Thunderbolt* (Right Arm Large Laser out)
- 1 *Rifleman* (Add 1 to *Piloting Skill* rolls for faulty Gyro)
- 1 *Wasp*

##### Recon Lance

- 1 *Crusader* (Torso Armor reduced to 28)
- 1 *Shadow Hawk* (Add 2 points extra heat/turn)
- 1 *Wasp*
- 1 *Stinger*

##### Ground Units

- Hover or tracked armor totalling no more than 120 tons
- Mechanized Infantry totalling no more than 90 tons

#### Deployment

The Marik force may enter from the north end of the map area, beginning with the first turn.

## SITUATION: MID-MORNING, 1 APRIL 3028 (TC)

**Victory Conditions**

The 'Mechs of the 4th Light Assault Group are assigned points according to the scale given under Victory Points on page 33.

The Attacker may also add 2 points for every game turn before Turn 15 that any one of his 'Mechs escapes off the south end of the map. Thus, if a 4th Light Assault 'Mech exits the map to the south on Turn 9, the Attacker may add 12 points ( $15 - 9 = 6 \times 2$ ) to his Victory Point total.

The Attacker's goal is to get as many BattleMechs through the pass and off the south end of the map as he can. His success is judged on the following table:

ATTACKER VICTORY TABLE	
Victory Points	Results
60 points or more	Spectacular Victory
45 - 59	Decisive Victory
35 - 44	Partial Victory
25 - 34	Marginal Victory
1 - 24	Major Defeat
0	Utter and Complete Defeat

The Defender accumulates the listed Victory Points for each enemy 'Mech he destroys. Beginning with Game Turn 6, he adds 2 points for each game turn the Attacker has not yet succeeded in getting a 'Mech across the south map edge. Thus, if the first Attacker 'Mech escapes across the south map edge on Game Turn 11, the Defender would get 10 points ( $11 - 6 = 5 \times 2$ ) toward his own Victory Point total for having delayed the enemy that long.

The Defender judges his point totals according to the following table:

DEFENDER VICTORY TABLE	
Victory Points	Results
40 points or more	Spectacular Victory
30 - 39	Decisive Victory
20 - 29	Marginal Victory
Less than 20	Failure

Note that it is possible for both sides to claim victory in this action.

**Special Rules**

The east and west borders of the map area are steep, high canyon walls. 'Mechs may not exit the map in these directions. The special hexes at 0301 and 1217 on the **CityTech** mapboard are exceptions. Gray Death 'Mechs may enter the board from these hexes, and they may exit the board at the same points. The openings are unknown to the 4th Light Assault 'Mechs, however. The rules in FASA's **CityTech** should be used for combat in the town of Drango.

Finally, the Defender may secretly designate any 6 hexes on the mapboards as the location of buried explosive charges. These hex numbers are recorded but not revealed to the Attacker. They may be adjacent or separate, and may be detonated at the same time or on different game turns, as desired.

Each detonation causes  $1D6 \times 10$  points of damage to each 'Mech in the hex at the time of the blast, and adds  $1D6 \times 2$  points of heat. If the detonation occurs along one of the cliff walls (the east or west sides of the mapboard), a landslide will occur, blocking that hex and all adjacent hexes with rubble. The landslide will cause an *additional*  $1D6 \times 5$  points damage to any 'Mech standing in an affected hex, and those hexes become Level 1 Elevation. (It will have no effect on hexes already designated Level 1 or higher.)

I think every man in the Fourth L.A. except Captain Maranov knew we were charging headlong into a trap.

Drango is a village on the main road that runs through Drango Pass, from the northern highlands to the Vermillion Plains in the south. It was the main route south from the Marik staging area near the Helmhold ruins, and is most central of three possible routes across the Nagayan Mountains. Colonel Langsdorf sent House Marik's 4th Light Assault Group through Drango Pass, with orders to move quickly to seize the southern approaches to all three passes. Thus was Captain Maranov almost an hour in advance of the other Marik units when he reached Drango near the midpoint of the valley called Drango Gap.

Carlyle's forces were waiting for him.



# SCENARIO 2

## LEE'S PASS

Excerpted from *Mechs of Flesh and Blood*, by Lori Kalmar, Avalon Press, 3045.

Armchair strategists have debated the wisdom of Grayson Caryle at Helm for years. No doubt, they'll still be debating it centuries from now. When examined coldly, analytically, his plan seems not merely logical, but obvious. Faced with three advancing columns, each larger than his own force, what else was there to do but confront each one separately, one at a time? Damage each column in turn, hurt it as bad as possible, then face the reunited columns on the Vermillion Plains after their numbers have been reduced, their confidence in themselves and their leaders shaken.

So it appears now. At the time, after the Battle of Drango pass, we knew only that we'd not hurt the first column as much as we'd wanted, knew that we had lost blood of our own. And now, marching up through that narrow defile, a second column, fresh, unbloodied—the 7th Marik Light Assault Group in full panoply of war.

It was sight enough to make the bravest of us tremble.

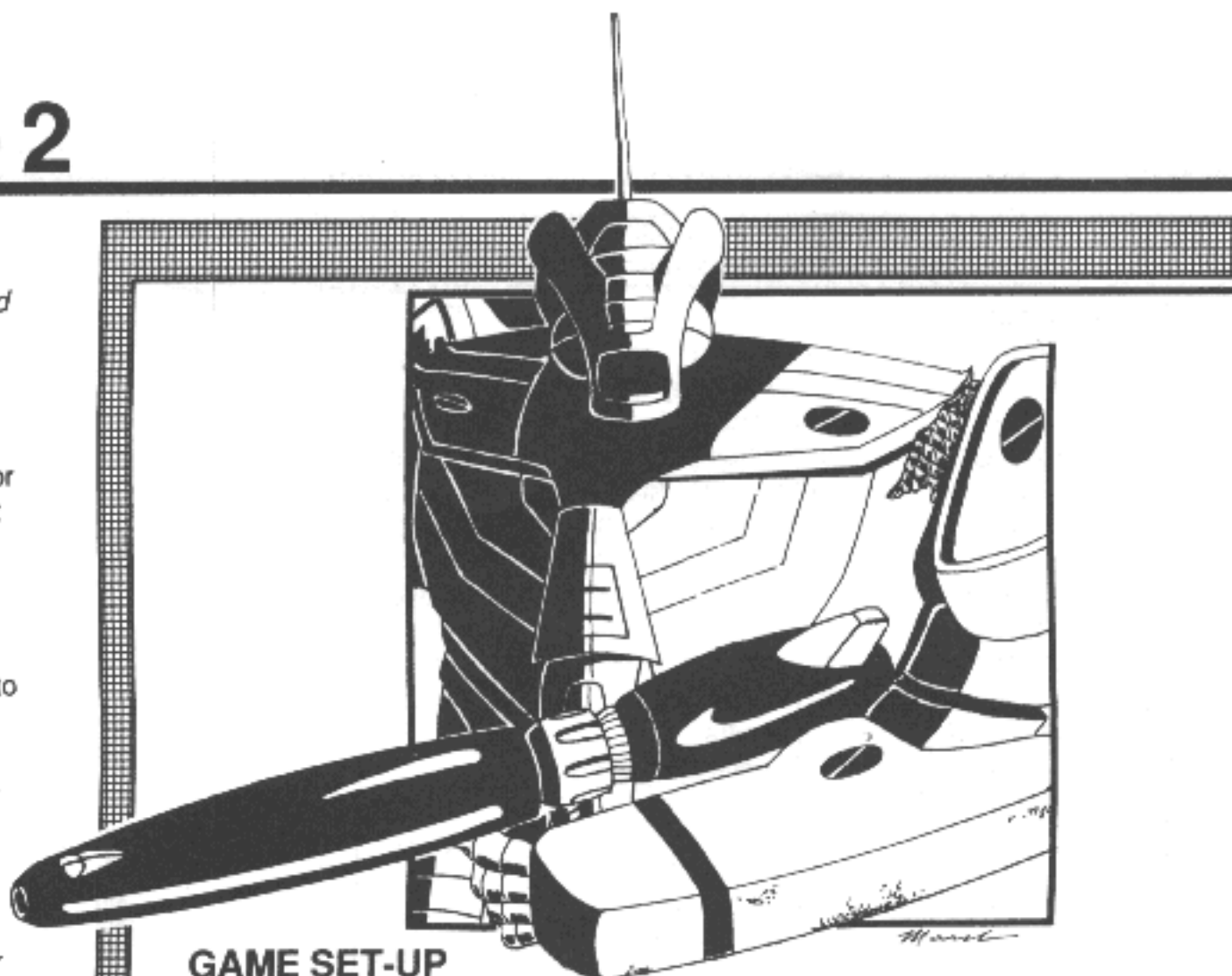
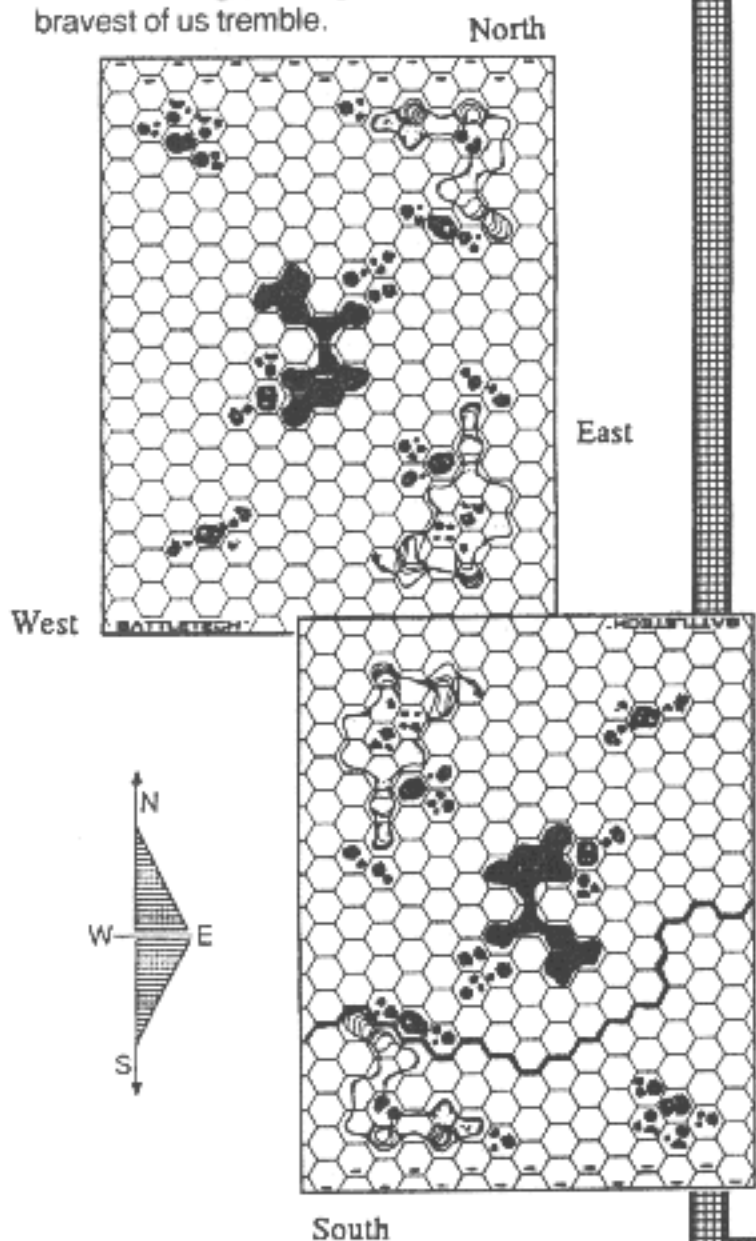

### GAME SET-UP

Lay out the two **BattleTech** game maps as shown. The battlefield area represents a narrow pass through the mountains, with a pair of waterholes present. Movement to the east and west is blocked by the steep walls of the canyon rift. The line of hexes shown in the illustration represents a change of level. Hexes on this line are Level 0. Hexes south of this line are Level 2, and represent a low ridge stretching across the floor of the pass.

All clear terrain is treated as rough terrain in this engagement.

### Defender

The Defending force consists of the Gray Death BattleMechs and ground units that survived the encounter at Drango Pass. To these, he may add foot infantry and/or mechanized infantry totalling no more than 80 tons, which are already in place at Lee's Pass before the battle begins.

### Deployment

The Defender deploys first, and has the initiative. The Hex 0115 on the South Map represents a narrow cleft in the canyon wall leading to a series of passageways through which the Defender 'Mechs travelled to reach Lee's pass after the engagement at Drango. Defender 'Mechs may deploy off the map, and enter one per turn at Hex 0115 at any time during the course of the scenario.

### Attacker

The Attacking force consists of the 7th Light Assault Group, and includes the following:

- Command Lance
  - 1 *Shadow Hawk* (Right Arm, 18 points armor)
  - 1 *Wolverine* (Center Torso, 17 points armor)
  - 1 *Wasp*
  - 1 *Stinger*
- Fire Lance
  - 1 *Thunderbolt* (Add 3 heat points when firing Large Laser)
  - 1 *Shadow Hawk*
  - 1 *Wasp*
- Recon Lance
  - 1 *Stinger*
  - 1 *Wasp*

## SITUATION: MIDDAY, 1 APRIL 3028 (TC)

**Victory Conditions**

The 'Mechs of the 7th Light Assault Group are assigned points according to the scale on page 33.

The Attacker wins the listed number of Victory Points for each of his 'Mechs that exits the south end of the map. He may also add 2 points for every game turn before Turn 15 that any one of his 'Mechs escapes off the south end of the map. Thus, if a 5th Light Assault 'Mech exits the map to the south on Game Turn 9, the Attacker may add 12 points ( $15 - 9 = 6 \times 2$ ) to his Victory Point total.

The Attacker's goal is to get as many BattleMechs through the pass and off the south end of the map as he can. His success is judged according to the following table:

ATTACKER VICTORY TABLE	
Victory Points	Results
25 points or more	Spectacular Victory
18 - 24	Decisive Victory
12 - 17	Partial Victory
8 - 11	Marginal Victory
1 - 7	Major Defeat
0	Utter and Complete Defeat

The Defender accumulates the Victory Points listed above for each enemy 'Mech he destroys. Beginning with Game Turn 8, he adds 2 points for each game turn the Attacker has not yet succeeded in getting a 'Mech across the south map edge. Thus, if the first Attacker 'Mech escapes across the south map edge on Game Turn 11, the Defender would get 6 points ( $11 - 8 = 3 \times 2$ ) toward his own Victory Point total for having delayed the enemy that long.

The Defender assesses his point totals according to the following table:

DEFENDER VICTORY TABLE	
Victory Points	Results
30 points or more	Spectacular Victory
21 - 30	Decisive Victory
15 - 20	Marginal Victory
Less than 15	Failure

Note that it is again possible for both sides to claim victory in this action.

**Special Rules**

This engagement is much like the battle at Drango, but the southern end of the field is dominated by the ridge line that splits the valley rift. This ridge creates a hillcrest dead-zone. 'Mechs at the bottom of the slope cannot fire at 'Mechs behind the line of hexes that marks the top of the ridge. 'Mechs behind the top of the ridge cannot fire at 'Mechs in the valley.

All clear terrain is treated as rough terrain in this action.

Again, the Marik troops must get as many 'Mechs off the south end of the board as quickly as they can, while the Gray Death must attempt to damage or destroy as many enemy 'Mechs as possible, delay them as long as possible, and escape with as little damage as possible.

Several kilometers to the west of Drango Gap lay Lee's Pass, a narrower passage twisting across boulders and other rugged terrain. The prominent feature here was the low escarpment called Dry Ridge, which completely blocked the southern neck of the valley.

Colonel Langsdorf sent the Marik 7th Light Assault Force through Lee's Pass. Though he did not know the exact route taken by the Gray Death, Langsdorf wanted to be certain that they did not try a countermarch north through a side pass to fall on the Marik base camp while the majority of his forces were south of the Nagayan Mountains. The 7th Light Assault was actually a second-line company. It had been badly chewed up at the Battle of Yalin Station, and its TO&E included more light scout and medium 'Mechs than was usual for an assault line unit. Its operations on Helm so far had been confined to scouting missions and light garrison work, for which it was well suited.

Langsdorf was certain that the Gray Death was already clear of the Nagayan passes and well to the south, and that if Chu encountered any enemy units at all, they would be light rear guards or lone scouts. The 7th's commander, Captain Chu Shi-Lin, was not as optimistic as his commander when he received his orders. He was heard to remark before the battle, "That pass looks like the perfect place for an ambush."

He was right.





# SCENARIO 3

## VERMILLION VALLEY

From the statement made by James T. Tarlborough, former Captain of the Marik 12th Light Saber Legion, at his court martial, 3028

The 12th Light Saber Legion entered Helm's Vermillion River Valley in mid-afternoon, 1 April, 3028 Terran Calendar, pursuant to Colonel Langsdorf's orders. I wish to state that I protested my orders at that time, requesting that they be presented in writing by Colonel Langsdorf himself. The reason for my concern was obvious. The 12th had suffered heavily in the earlier fighting on Helm, and in my judgement, the unit had not yet recovered its fighting spirit. Of the Six 'Mechs remaining under my command, only the *Wasp* was undamaged, and the conventional mechanized forces detached to cover the 12th's movement had suffered as heavily as we.

Further, the task we faced was daunting. Our way was blocked by a broad river of uncertain depth. Scouts had reported that there were fords in the area, but the precise location of these fords was unknown to us. When first entering the valley, we had heard the sounds of heavy firing in the distance and surmised that other elements of the Colonel's multi-pronged advance had made contact with the enemy. Nonetheless, there was grave concern that they would attempt to ambush us along the banks of the Vermillion River.

Subsequent events bore out that premonition.



### GAME SET-UP

Lay out the two **BattleTech** game maps as shown. The shaded portion represents a broad, shallow river, the Vermillion, winding south through a narrow valley.

The river is considered Depth Level 1 throughout its length, except for five fords of Depth 0 known only to the Defender. The Defender should secretly note the locations of these five fords for later reference.

#### Defender

The Defender has the 'Mechs surviving from the Battles of Drango and Lee's Pass. After an all-night march from Lee's Pass to the west, they approach the Vermillion Valley. The Defender sets up first, and has the initiative.

#### Deployment

The Defender may deploy his 'Mechs wherever he desires. Hex 1217 is an opening into the east bluffs above the valley, through which the Defender may travel on his way from the earlier battles. The Defender's 'Mechs may be deployed off the board, to appear on any desired turn, one 'Mech per turn, in Hex 1217.

#### Attacker

The Attacking force consists of the remnants of the 12th White Saber Legion. This unit, bloodied in earlier battles on Helm, consists of the following:

- Command Lance/Recon Lance
  - 1 *Warhammer* (Right Torso armor at 12/8; Right Arm armor at 15)
  - 1 *Archer* (Right Torso armor at 20/4; -1 to *Piloting* Rolls for faulty Gyro)
  - 1 *Shadow Hawk* (Head armor at 6; 2 extra heat points/turn)
  - 1 *Wasp*
- Fire Lance
  - 1 *Thunderbolt* (Large Laser adds 5 points of heal/shot)
  - 1 *Wolverine* (Center Torso Armor at 15/8)
- Ground Units
  - Ground or hovercraft armor totalling no more than 50 tons
  - Mechanized Infantry totalling no more than 70 tons

#### Deployment

The Attacker enters anywhere on the north end of the map on Turn 1 or after.

## SITUATION: VERMILLION RIVER VALLEY, LATE AFTERNOON, 1 APRIL 3028 (TC)



### Victory Conditions

The Attacker gets Victory Points for each of his 'Mechs that exits off the south edge of the map. The list of points for each 'Mech is given on page 33.

The Attacker also gets 2 points for every game turn before Turn 10 that he can move the first of his 'Mechs off the south edge of the board. Thus, if his first 'Mech moves off the board on Turn 5, he gets 10 extra points toward his Victory Point total ( $10 - 5 = 5 \times 2$ ).

The Attacker's victory can be assessed on the following table.

ATTACKER VICTORY TABLE	
Victory Points	Results
40 or more points	Spectacular Victory
25 - 39	Decisive Victory
18 - 24	Marginal Victory
1 - 17	Defeat
0	Utter defeat

The Defender scores points toward his own total. He may add 2 points for every turn after Turn 5 that he delays the enemy, until the first enemy 'Mech crosses the south edge of the board. His victory is judged according to the following table.

DEFENDER VICTORY TABLE	
Victory Points	Results
30 or more points	Spectacular Victory
21 - 29	Decisive Victory
10 - 20	Marginal Victory
9 or less	Failure

The Defender may withdraw across the south edge of the board at any time, but may not return. He may withdraw through Hex 1217 at any time, and return.

### Special Rules

**Fords:** The Vermillion River poses a minor obstacle to 'Mechs on both sides, reaching to the machines' waists in most areas. The five hexes of Depth 0 secretly recorded by the Defender represent areas where the water is only a meter or two deep and poses no obstacle at all to BattleMechs.

'Mechs may test for fords by the simple expedient of entering the water. Depth 1 hexes will cost 2 MP to cross, while Depth 0 fords will cost only the usual 1 MP. The Defender must tell the Attacker when one of his 'Mechs has entered a ford hex. Tactical doctrine calls for heavy 'Mechs to lay down covering fire, while scout 'Mechs search for fords, though some commanders prefer to forge ahead despite all obstacles.

To the east of Drango Pass lay the Vermillion River, a narrow, deep, and swift-running river that had carved the Nagayan Canyon through which it ran. The northern end of the canyon lay near a branching of the road north of Drango. The canyon itself offered an alternate route north or south past Drango, which Langsdorf was determined to exploit. He ordered the 12th White Saber Legion, a line 'Mech company already battered and weakened by earlier clashes with the Gray Death on Helm, to take the Vermillion River passage south. They were to sweep the area for possible Gray Death detachments or scouts, and rendezvous with the 4th and 7th on the broad flood plain of the Vermillion south of the mountains.

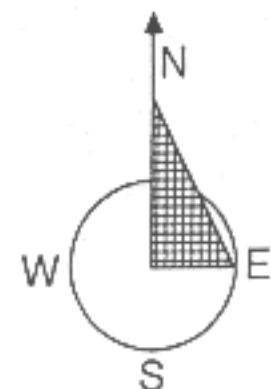
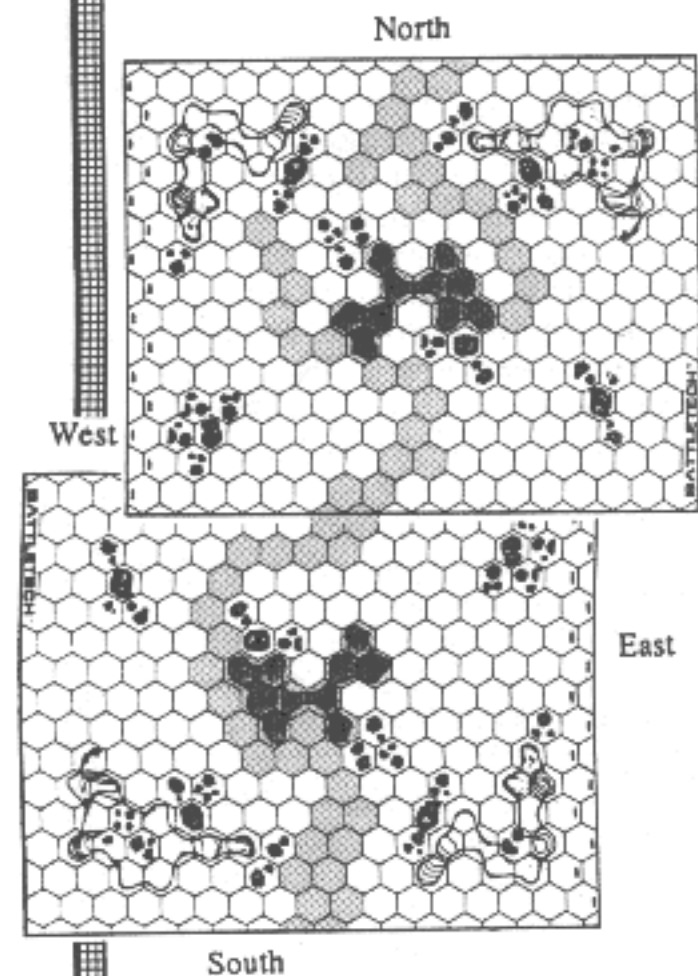

# SCENARIO 4

## FINAL BATTLE

Excerpted from *Mechs of Flesh and Blood*, by Lori Kalmar, Avlon Press, 3045

By that evening, we were exhausted—those of us who still lived—and our machines were giving out. We had been fighting almost without pause hour after hour. Our hands were shaking, our eyes blurring. Our bodies were drenched in the sweat that pours out when a MechWarrior gets enclosed in that hothouse they call a cockpit.

How long would we be able to continue? Thrice we had met the enemy. Each time we had worn away his numbers. Each time we had suffered losses—irreparable losses—of our own. For the first time, I heard grumbings among the men, the bitter words of troops pushed too long and too hard, men who have long since passed the point where anyone else would have snapped.

But their discipline held.

"One more time," Grayson told us. The three columns had united and were bearing down on our LZ. The DropShips were being loaded at our backs. If the enemy's columns passed us, the transports would be destroyed and our doom sealed. To stop them meant we had to go into combat one last time. The trouble was, each of us knew too well that this could be the last time, in truth, for ever.

Grayson gave the command.

"Forward!" and his battered and scar-torn *Marauder* lumbered ahead.

It advanced alone. For one aching moment, I wondered—would any of them follow? Would I? What he was asking of us was impossible, and yet...

David McCall lurched after him first, his shattered *Rifleman* still trailing debris from the arm that had been shot away at the battle above the river. Delmar Clay's *Wolverine* was barely standing, with gaping, shot-torn craters in its torso and legs, but it managed to move forward, too.

Then we were all following. To this day, I don't know that any of us made a conscious decision to follow him. All we knew was, that crazy fool was going to meet the enemy alone...and we had to follow.

North

Map 2

West

Map 1

South

### GAME SET-UP

The game maps are set up as shown. The lakes are treated as open ground. All other terrain is handled normally.

This is the Defender's final chance to turn back the Attacker, but the battle will not take place unless the Attacker has at least 40 points worth of BattleMechs (calculated from the Victory Point totals) when he combines the survivors from all three forces. If fewer than 40 points remain, the players may agree to make up the difference in Marik reinforcements, which arrive on the field through the Drango Gap just before the battle begins.

#### Defender

The Defending forces are the survivors of the three earlier battles, plus the following 'Mechs drawn as reinforcements from the loading operation at the nearby DropShips:

- DeVillar's *Griffin*
- Kent's *Phoenix Hawk*
- 2 *Stingers*
- Hovercraft armor and/or Mechanized Infantry totalling no more than 80 tons

#### Deployment

The Defender may deploy anywhere on the map.

## SITUATION: VERMILLION PLAINS, EARLY EVENING, 1 APRIL 3028 (TC)

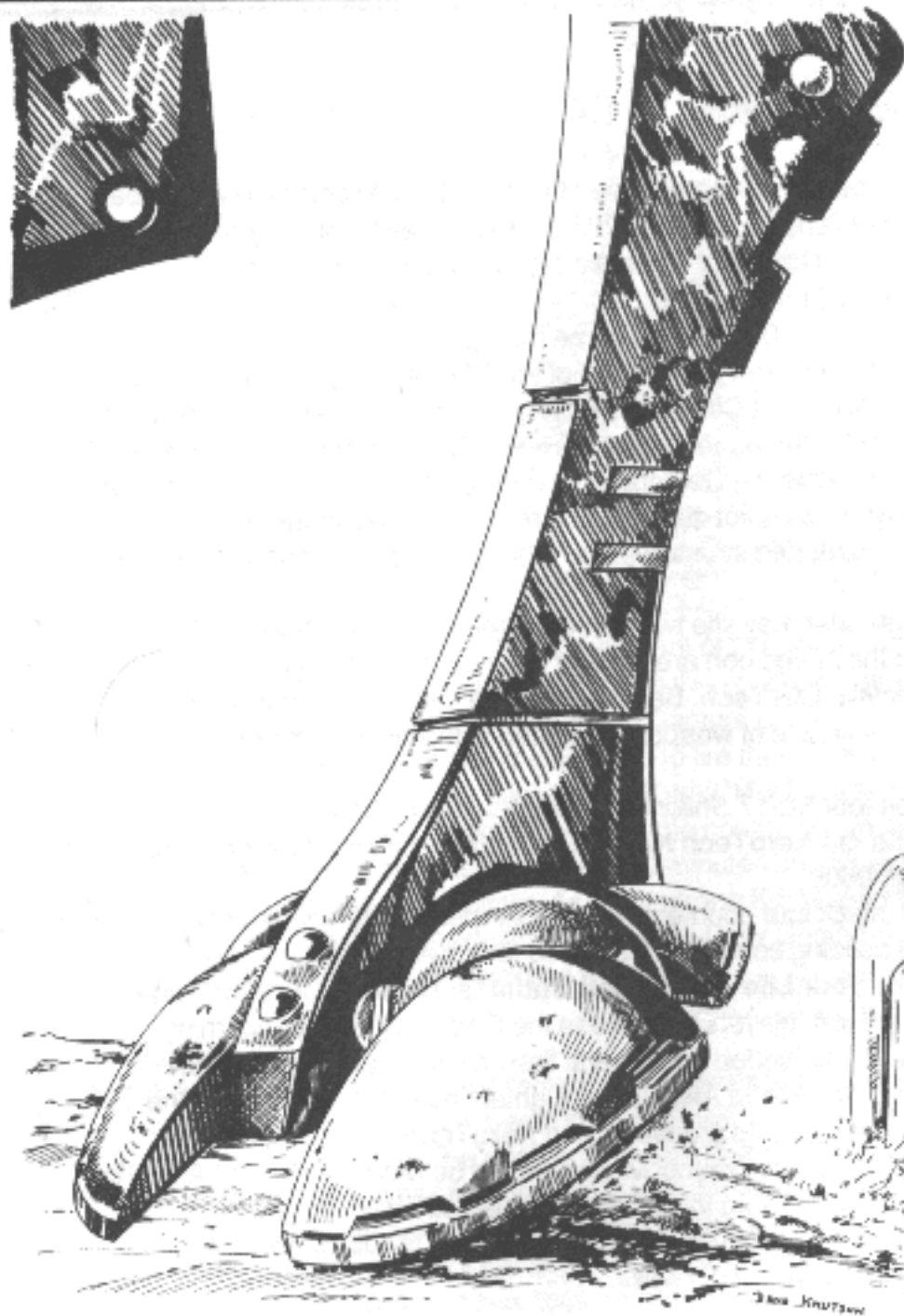

Carlyle's clever use of unexpected caverns and passes through the Nagayan Mountains had come as a nasty surprise to Langsdorf, but the Colonel was by no means defeated. Though he had lost a number of 'Mechs and many more were badly damaged, he still had enough sheer firepower to break through the Gray Death's defensive line and to prevent the loading and lift-off of the mercenary company's ships. Capture those ships and Carlyle would have to give up the fight and shut down his 'Mechs.

Langsdorf knew that the coming confrontation on the Vermillion Plains was the last opportunity Carlyle would have to turn back the House Marik expeditionary force.

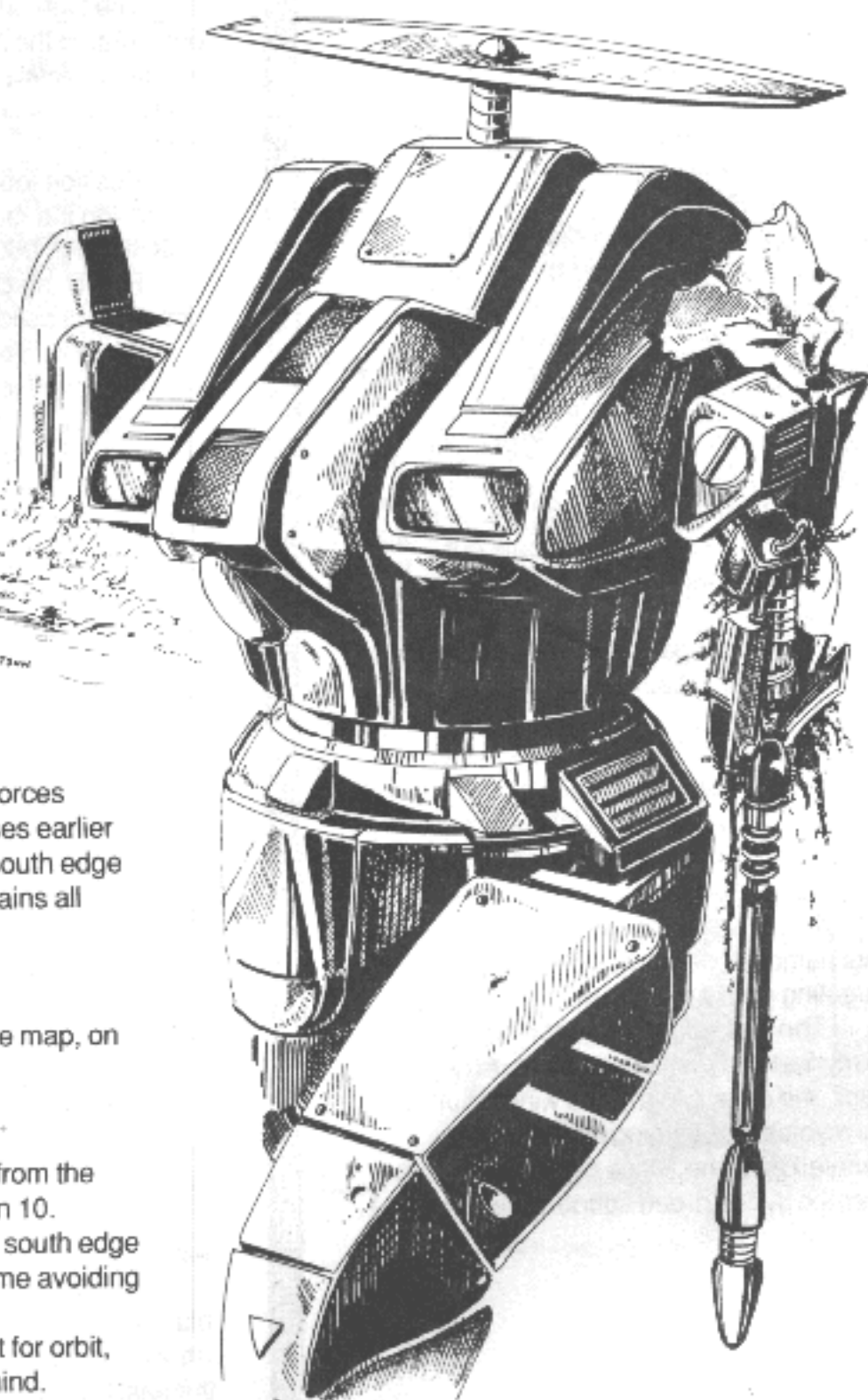

### Attacker

The Attacker consists of the surviving 'Mechs and ground forces from the three units that started south across the mountain passes earlier in the day. Only those 'Mechs and combat units that exited the south edge of each battlefield are used, and each 'Mech or other vehicle retains all damage suffered earlier in the engagement.

### Deployment

The Attacker deploys anywhere along the north edge of the map, on Turn 1 or after.

### Victory Conditions

The Attacker wins by exiting at least 20 points (calculated from the table on page 33 off the south edge of the map on or before Turn 10.

The Defender wins by exiting all surviving 'Mechs from the south edge of the map *after* Turn 6 and *before* Turn 12, while at the same time avoiding the Defender's victory conditions.

On Turn 12, the last of the Defender's DropShips will boost for orbit, and Defender 'Mechs still on the map at that time will be left behind.

# RUN FOR YOUR LIFE

## LIGHTNING STRIKE

Excerpted from *Hot Pilot, Hot Sky*, by Rai Olessen, as told to Thorvid Klein, Thunder Press Interstellar, Merton, 3031

We were working for House Kurita then, a standard contract that had us flying aerospace cover for the big Combine DropShips hauling vanadium and chromium into the black. When the sky fell, we were at Trogport, attached to the 31st High Assault Company of Sandoval's Slashers. We didn't have much warning that the Steiner 'Mechs were burning in. One moment, everything was peaceful, and the next the sky was lit from horizon to horizon with flares and chaff and targeting beams, and the raid sirens were moaning like a dirge.

It took better than an hour to sort out the fragments of intelligence that came filtering in. And the news was not good, believe me. From the sound of things, the Gray Death was down and running five clicks to the east.

We'd boosted immediately, of course, as soon as the sirens went off, to keep our wing from being fried by an incoming warhead or a berserker 'Mech. Then we landed, refueled, and set out again, quartering the darkness to the east, looking for the grounding point of the enemy 'Mechs.

All that was left after that was to sit tight and wait. There were scouts out there in the eerie near-darkness of Dyev's long night. When they had a target for us to pounce, we'd get the word, and then Carlyle's Gray Death Legion would be just a bad memory.

I spent the dragging hours in the flight ready room, using a lap viewer to run through recognition shots and stats of the Gray Death's machines. I recognized that battered-looking *Marauder* as Carlyle's 'Mech, and was looking forward to getting that particular death machine in the HUD targeting grid of my *Slayer*.

The blast of the raid siren brought me to my feet in a rush of adrenalin. At my back, the other pilots of the wing leapt from sofas and gaming tables and sprinted after me. Once outside, we were greeted by the dread sound of incoming missiles.

## GAME SET-UP

This scenario requires all three of FASA's **BattleTech** tactical combat games: **BattleTech**, **CityTech**, and **AeroTech**. If air-to-ground combat occurs, set up that phase of the battle on the low-altitude mapsheet included in **AeroTech**.

Lay out the two **BattleTech** game maps and one of the mapboards from **CityTech** as shown. The paved area of the **CityTech** map represents the spaceport facility. Eight **CityTech** building counters should be set up at the edge of the field in the general area of Hexes 1309 through 0913. The exact arrangement is left to the Defender, but one building must be placed on Hex 1210 to represent the pilot quarters and ready area. Six of the eight buildings are hardened structures, the other two (representing hangars) are light.

The Defender may site two gun emplacements anywhere on the perimeter of the paved port area, using the rules given for gun emplacements in **CityTech**. Because the port has only recently been built, the Defender's choice of weapons is limited to missile launchers or autocannon.

Position four SL-17 *Shilone* fighters (the manta-shapes numbered 1, 2, 3, and 4 in the red **AeroTech** Kurita counter mix), one per hex, on Hexes 0606 through 0609.

Finally, stack four counters with readily identifiable front and back sides on the building counter in Hex 1210 to represent the unit's pilots.

**Run For Your Life** uses **Expert BattleTech** rules. For combat on and near the spaceport, players should use the **CityTech** rules concerning buildings, including hidden movement, fires in cities, and gun emplacements. If any of the Kurita AeroSpace Fighters manages to get airborne, air-to-ground combat should proceed using **AeroTech** rules. The relative positions of the various ground 'Mechs should be recreated on the **AeroTech** low-altitude map, allowing the fighters to make strafing runs and to receive fire in return. Combat on the ground and in the air is coordinated as described below in **Special Rules**.

### Defender

After setting up the buildings, defenses, and fighters at the port, the Defender may deploy his 'Mechs. He has one lance and a portion of another available for point defense. These consist of the following:

- 1 *Griffin*
- 1 *Shadow Hawk*
- 1 *Phoenix Hawk*
- 2 *Wasps*
- 1 *Stinger*

He also has the ground units of the base garrison, consisting of ground or hovercraft armor totalling no more than 100 tons, plus Foot and/or Mechanized Infantry totalling no more than 120 tons.

Defending units may be deployed anywhere on any of the maps. The Defender knows in advance that the Gray Death will be coming from the east.

### Attacker

The Attacker is the Gray Death Legion, consisting of all three lances, plus conventional ground support units totalling no more than 250 tons (the Attacker's choice of armor, Foot, and/or Mechanized Infantry). They enter the east end of the map area on Turn 1 or after.

## SITUATION: DYEV, 2 AUGUST 3029 (TC)

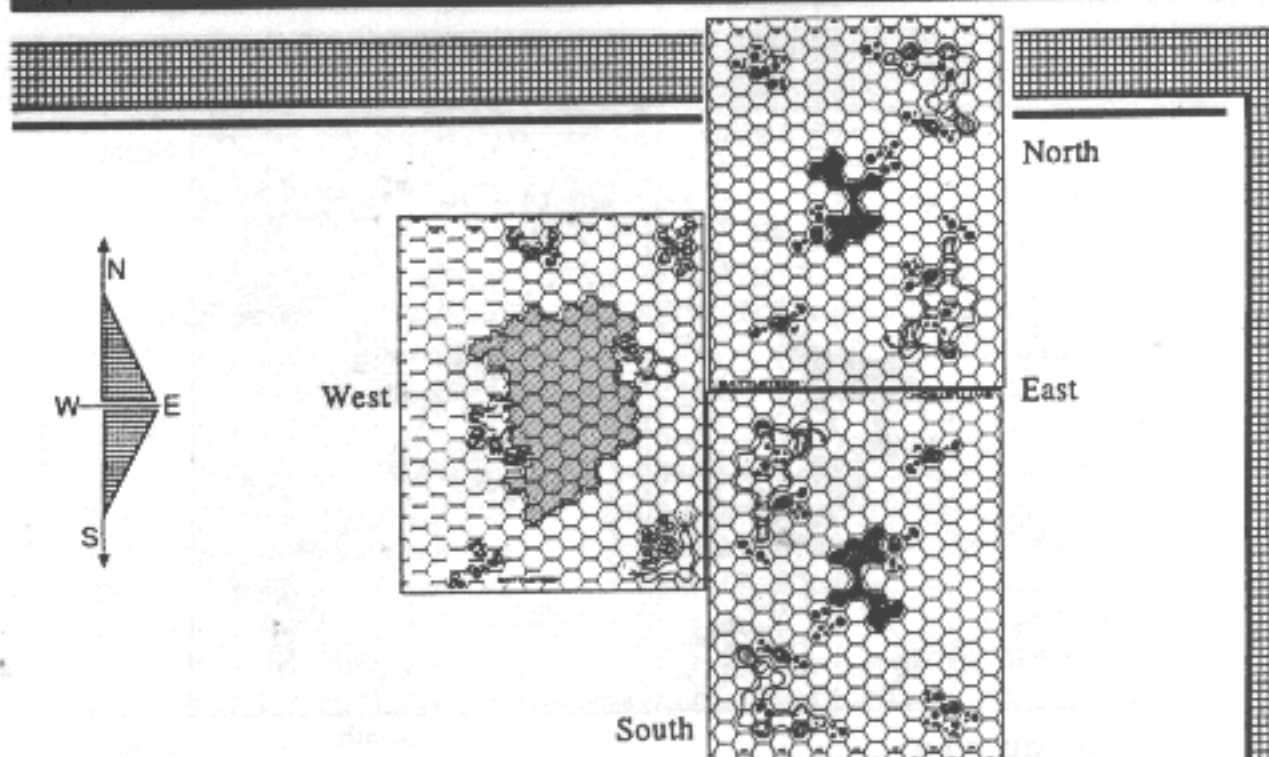
**Victory Conditions**

The Defender wins if he can prevent the capture of the spaceport before Turn 20. The Attacker wins if he can capture the spaceport by Turn 20 and destroy or capture all four enemy fighters. Capture of the spaceport is defined as no enemy 'Mechs still able to fire their weapons on any hex of the **CityTech** mapboard. If any active Kurita 'Mechs remain on the **CityTech** map on Turn 20, consider the port to be contested, delaying the arrival of Steiner reinforcements for another 90 minutes because the DropShips cannot come down from orbit. As other strong Kurita ground forces are in the area, a 90-minute delay will force the Gray Death to retreat, and their mission will be considered a failure.

**Special Rules**

Kurita AeroSpace Fighters must remain on the ground until activated by their pilots. On Turn 1, pilots may begin their dash from the ready room at Hex 1209 to their spacecraft. The dash is made on small, electrically-powered vehicles that may travel two hexes per turn. More than one vehicle may occupy a single hex, but all vehicles (and pilots) in a single hex are subject to combat results of fire directed at that hex. Any BattleMech weapon hit scored on a hex occupied by pilot vehicles will kill a pilot on a 2D6 roll of 8+, with 2D6 rolled separately for each pilot in the hex.

When the pilots occupy the same hex as a grounded spacecraft, they must spend one additional combat turn in that hex as they enter their fighter, check out the systems, and ready their craft for takeoff. A counter will enter the fighter's hex on one turn, spend the next turn motionless (marked by flipping the counter over), and launch on the turn after that.

Fighters parked on the ground are much easier targets than fighters in motion. As long as they are on the ground, treat each fighter as a shut down BattleMech. They may not move or engage in combat until powered up and off the ground. Each damage point inflicted on a grounded fighter will destroy two of the aircraft's armor points.

Airborne fighters use the rules given in **AeroTech** to carry out air-to-ground strafing and bombing runs.

Once in the air, the fighters are hard to hit and harder to destroy. The Attacker's best chance is to get among the grounded fighters as rapidly as he can, doing as much damage as he can.

The Defender's turn will come if he can get any of his fighters off the ground.

The Gray Death has drawn the important but unenviable assignment of neutralizing a key airspace base and combat wing attached to the Kurita planetary garrison of Dyev. Carlyle's 'Mechs were dropped out of range of local defenses, then quickly marched through rough terrain to a point where they could strike at the spaceport before the enemy could launch its AeroSpace Fighters.

Once airborne, the fighters would present a serious threat to Carlyle's 'Mechs. The key was to destroy or cripple them—or as many of them as possible—while they were still on the ground. This meant sneaking as close to the perimeter fence as possible, past inexperienced guards in the darkness of Dyev's long night, then striking quickly across the intervening terrain, with the parked fighters as their primary targets. Once the base was secure, it would provide an ideal landing port for incoming Steiner DropShips.

From Carlyle's point of view, the problem was twofold. For his weapons to have any effect, he had to get as many of his 'Mechs in as close as he could and as quickly as he could. At the same time, his strike 'Mechs would be coming under intense fire from the base defenses, fire that his men would have to ignore if they were to accomplish their mission.

If the Kurita AeroSpace Pilots could get but a few of their spacecraft into the air, it would become open season on the Steiner 'Mechs.



# BREAKOUT AT KO

## A SOUND PLAN

Excerpt from *Of War and Remembrance: Memoirs of Grand General Handley Baker*, by Handley Baker, GG, pD, (ret.) and Sidnis Greelend, Luthien-Dragon Press, 3052.

Battle smoke scudded thick and impenetrable across the fire-blasted heath. My *Marauder* lurched and stumbled over a protruding bit of wreckage I'd not seen from the cockpit. Baldur was a dreary world of ice sheets and tundra, with only the narrow, tree-choked equatorial girdle a fit place for humans. Why either side wanted the godforsaken place was beyond me. But Baker's Bashers had orders to hold Ko against the enemy invasion, and that was precisely what we were going to do.

The Bashers were moving north toward the enemy LZ, probing through the smoke. From what Colonel Karlssen had briefed me before dawn, I was sure the enemy perimeter had to be stretched mighty thin at this point. If the Bashers could tie down a significant portion of those perimeter defenses, a few more companies might slip through the gap. Let some Mech companies loose in the rear areas and there'd be hell to pay—supply dumps blown, untended Mechs blasted or captured, command and communication posts wiped out. Why, we could knock out the Steiner invasion of Ko before it had properly begun. The Bashers had been ordered in to flush the enemy. We carried enough firepower to take on most anything they could throw at us, and we were ready for it, eager and hungry.

"Basher One, this is Four," an electronic voice droned in my helmet phones. Three hundred meters ahead of the rest of the pack, Kroton's *Stinger* was acting as Lance scout. "I've got emma at nine o'clock."

"I've got it, Four." My motion sensors and IR gear had picked it up, a flicker of movement, a glow of heat behind the smoke. "Check it out."

"I copy, One. Estimate range at one-three-zero, bearing one-eighty. I think... oh, God!"

Four missiles stitched along my *Marauder's* port hull, the detonations coming like the rattle of a machine gun and slamming me hard against the seat restraints. It took me long seconds to identify the high-pitched keening that was tearing at my ears through the helmet phones. It was Kroton's screaming.

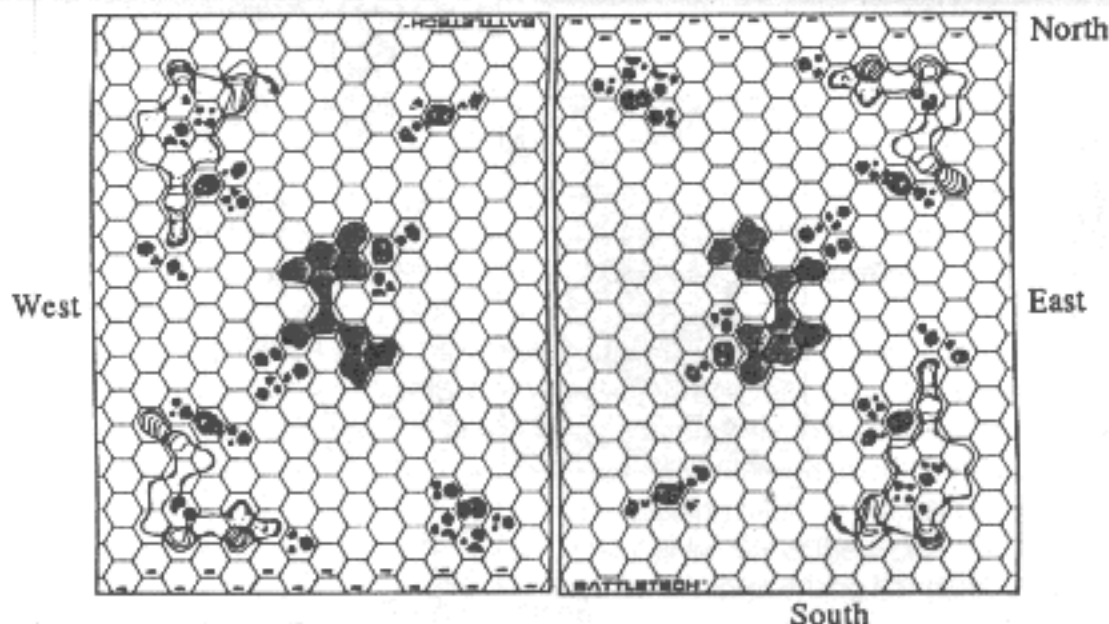

## GAME SET-UP

Lay out the two **BattleTech** maps as shown. The Defender is Grayson Carlyle and his entire Gray Death Company. The company is augmented by conventional ground forces (which may consist of any mix of ground or hover vehicles, Mechanized, Foot, or Jump infantry, totalling no more than 300 tons.)

The Attacker has the following forces:

### Baker's Bashers

#### Command Lance

- 1 *Marauder* (Baker)
- 1 *Thunderbolt* (Large Laser produces 2 extra Heat Points/shot)
- 1 *Griffin* (10 Heat Sinks)
- 1 *Stinger*

#### Fire Lance

- 2 *Archers*
- 1 *Shadow Hawk*
- 1 *Wasp*

#### Recon Lance

- 1 *Shadow Hawk*
- 1 *Phoenix Hawk* (+2 on *Piloting* rolls due to faulty Gyro)
- 1 *Stinger*
- 1 *Wasp* (no jump)

### Black Dragons

#### Command Lance

- 1 *BattleMaster*
- 1 *Archer* (Head Armor 8)
- 1 *Rifleman*
- 1 *Griffin* (No jump; 8 Heat Sinks)

#### Fire Lance

- 2 *Archers*
- 1 *Thunderbolt* (12 Heat Sinks, SRM reloads exhausted)
- 1 *Stinger*

#### Recon Lance

- 1 *Phoenix Hawk*
- 1 *Stinger* (8 Heat Sinks)
- 2 *Wasps*

#### Ground Defense Forces

- Ground Armor totalling 200 tons or less
- Jump Infantry totalling 100 tons or less
- Mechanized and/or Foot Infantry totalling 160 tons or less

## SITUATION: BALDUR, MID-MORNING, 17 NOVEMBER 3029 (TC)

The Attacker enters anywhere on the north end of the map. He may hold back as many of the above listed 'Mechs as desired, not entering them in the battle. How many 'Mechs he engages in the battle will have a bearing on the final outcome, as discussed below under **Victory Conditions**.

The Attacker may also bring additional 'Mechs into the battle from his reserve units. He must position the 'Mechs to be deployed for one full combat turn just off the map adjacent to the hex in which they will appear in the *next* turn. They may not take part in combat until they actually enter the map.

'Mechs that exit the map at any time may not return on a later turn. Attacker 'Mechs that exit the map do not count toward the Attacker's Victory Point total.

Before the scenario begins, the Defender should secretly choose one of the following courses of action:

1. Exit as many 'Mechs as possible off the east edge of the map.
2. Exit as many 'Mechs as possible off the west edge of the map.
3. Exit as many 'Mechs as possible off the north edge of the map.
4. Stand fast and tie down as many enemy 'Mechs as possible.

### Victory Conditions

The Attacker must destroy, cripple, or pin down the Gray Death Legion with as few of his available 'Mechs as possible. Each of the Attacker's 'Mechs are given a point value. Each 'Mech weighing 20 tons or less counts as 1 point. 'Mechs weighing between 20 and 65 tons count 2 points each. 'Mechs over 65 tons count 4 points each. The Attacker must keep the Defender in the map area, or destroy him, by Turn 15. The Defender must remain on the map through Turn 8, but may exit on any turn after.

Because the Attacker does not know which of several possible courses of action the Defender might take, there is room for the Defender to pull an unexpected maneuver, or to feint with one part of his force while he executes his move with the rest. The Defender may, for example, mislead the Attacker by exiting some 'Mechs off a different edge of the board than the one originally chosen.

The Attacker has a reserve force of 'Mechs that he can enter into battle as needed.

The Attacker wins if he wipes out all Defender 'Mechs *and* has reserved at least 25 points worth of 'Mechs that were not brought onto the map, *and* still has at least 15 points of 'Mechs on the board. Reserve 'Mechs that are waiting to enter the battle adjacent to the mapboard do not count in either group.

He also wins if no more than three Defender 'Mechs have left the board by Turn 15, *AND* he has reserved at least 35 points worth of 'Mechs not engaged on the map *AND* still has at least 15 points of operable BattleMechs on the map.

The Defender wins if he carries out his secretly chosen plan—either exiting four or more 'Mechs off the north, east, or west edge of the map between Turns 8 and 15, or remaining on the map and forcing the Attacker to commit so many 'Mechs to the battle that he has less than 30 points of BattleMechs in reserve.

If the Attacker destroys or forces all Defender 'Mechs off the map, but retains less than 30 points of 'Mechs still in reserve, both sides may claim victory. Such is always the case in a combat situation where the battle plans of the opponents are not diametrically opposed.

Having secured the LZs for its invasion of Baldur, the Steiner command had thrown out a broad perimeter of BattleMechs to protect the incoming and grounded DropShips as they disgorged regiment after regiment of Commonwealth combat machines and veterans. The Gray Death Legion occupied a broad front to the south of the main LZ, near the village of Ko.

Colonel Pharren Karlssen of Kurita's Black Dragons faced a difficult situation. If he could swiftly breach the Steiner perimeter and get a large force of 'Mechs in among the grounded DropShips, he could do incalculable damage while the Baldur garrison was reorganizing itself for a counterstrike. Getting through that perimeter would take some doing, however, particularly as the key region was held by the now infamous mercenaries, the Gray Death Legion.

Karlssen had two companies at his disposal for the push, Baker's Bashers and the elite Black Dragons. His plan was to use as few 'Mechs as possible to savage the Gray Death, then hold the survivors at bay as he rushed the rest of his first-line 'Mechs through the gap in the perimeter and into the Steiner LZ.

It was a sound plan. The only catch was that enemy forces rarely do the expected—especially when they are commanded by Grayson Carlyle.

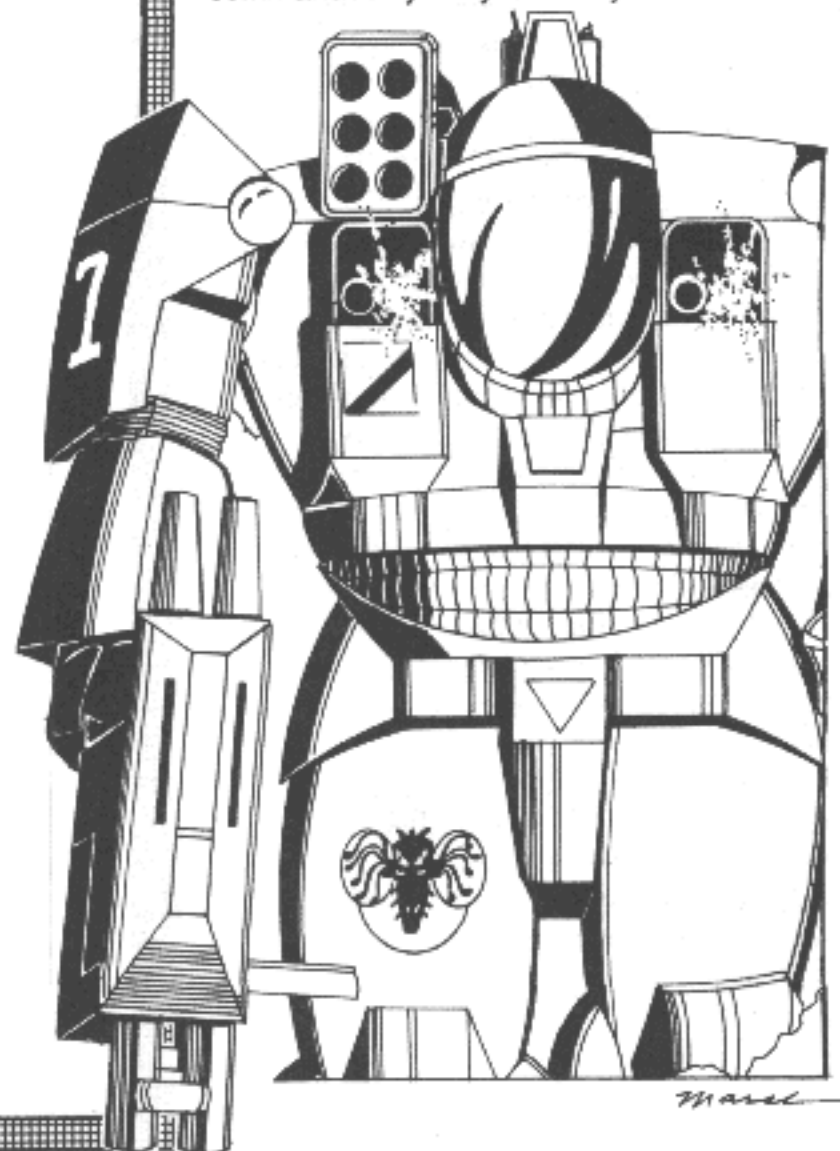



# RIPOSTE

## EXPECT THE UNEXPECTED

From edited transcripts of official *Court of Inquiry into the Professional Conduct of Captain Nicolo Yamashita, Section 45, Case 0113, Day 1, Convened 12 February 3030 (TC), Prime Base, Luthien.*

We'd heard the bad news from the Bashers just after our companies had started their march, but none of us figured it boded much trouble. It was true that the enemy had mauled the units Karlssen had sent in to open the way for us, but from all accounts, the other fellow had also been pretty well battered. Not more than a lance or two could possibly have slipped past Baker's people near Ko and now be on their way toward our column.

Still, I was a bit concerned. Captain Yamashita commanded both companies, and his orders were to ignore local resistance and push straight through to the Commonwealth LZs. Well and good, but Yamashita was a traditionalist of the old school. His style was orders-to-the-letter, do or die and damn the LRMs, full speed ahead—you know the drill. If it had been up to me, I'd have called for dispersal, everyone spread out, move fast, and rendezvous at the LZ, but the Captain, he liked to do it parade-style. I swear, if we'd had the time, he'd have had us polish and paint our 'Mechs with fresh combat honors and full decorations before the march.

It's just as well we didn't, because it would have wasted a lot of paint. The enemy 'Mechs came boiling out of the woods like rifticks, and I saw flame shoot up among the machines in the column ahead. For an instant I had a target, an enemy *Wolverine* dropping in on jump jets, scattering SRMs in a random, flame-shot cloud, then bounding out before I could get a lock. Then something kicked my *Shadow Hawk* from behind, and I had a blurred image of a *Marauder* ducking away into the trees. I recognized that machine from the ID files back at Base Prime. The grey and black paint scheme, the death's head emblazoned on scarlet were unmistakable.

I heard Yamashita barking orders over the com, and realized with a cold, lost feeling that his orders were to maintain formation, to keep the line straight. God...didn't he know? We were up against Carlyle's Gray Death!

## GAME SET-UP

Arrange the two **BattleTech** maps as in the configuration shown. (See below for the **Special Rules** on movement of mapsheets during the scenario). All Water hexes are considered Light Woods in this scenario. Prepare record sheets for all BattleMechs involved in the action. **Riposte** should be played using **Advanced** or **Expert BattleTech** rules.

### Defender

The Defender's forces are Companies A and B of the 39th "Ice Warriors", Baldur Garrison, House Kurita line infantry. All BattleMech pilots have *Piloting 5, Gunnery 4*.

#### Company A

##### Command Lance

- 1 *Thunderbolt* (Yamashita)
- 1 *Shadow Hawk* (Head Armor at 5 points)
- 1 *Wasp* (no Jump movement)
- 1 *Stinger*

##### Ortega's Fire Lance

- 1 *Rifleman* (Ortega)
- 1 *Rifleman* (Center Torso Armor, 17 points)
- 1 *Phoenix Hawk* (Left Arm Medium Laser out)
- 1 *Wasp*

##### Flannery's Recon Lance

- 1 *Stinger* (Flannery; Right Torso Armor, 4 points)
- 2 *Wasps*

#### Company B

##### Command Lance

- 1 *Warhammer* (Tomlin; Head Armor 7)
- 1 *Archer* (Right LRM 20 empty; Left Leg Armor 19)
- 1 *Shadow Hawk* (Center Torso Armor 18)
- 1 *Phoenix Hawk*

##### N'komo's Lance

- 1 *Rifleman* (N'komo)
- 1 *Rifleman* (Left Arm Large Laser out)
- 1 *Stinger*
- 1 *Wasp*

##### Venable's Recon Lance

- 1 *Phoenix Hawk* (Venable)
- 1 *Stinger*
- 1 *Wasp*
- 1 *Locust*

Ground Units (any mix of armor or infantry) totalling no more than 220 tons

### Deployment

The Defender deploys his two companies in the shaded areas marked on the map. The Defender deploys first.

### Attacker

The Attacker consists of those members of the Gray Death Legion who escaped off the map in the previous scenario. Some players may prefer to play this scenario with the entire Gray Death Legion present, disregarding the events of **Breakout**. The Attacker may enter the map from any map edge on or after Turn 1.

## SITUATION: BALDUR, MID-AFTERNOON, 17 NOVEMBER 3029 (TC)

### Victory Conditions

The Defender Companies A and B of the Ko Garrison must move north through the gap in the Steiner perimeter to attack the enemy's invasion staging areas. The Defender is to maintain formation and ignore attacks from independent fragments of the scattered enemy defenses.

The Defender's forces are assigned point values. 'Mechs weighing 20 tons are 1 point each, those weighing between 20 and 65 tons are 2 points each, while those over 65 tons are 4 points each. He receives points for each 'Mech that exits off the north edge of Map 6 (see **Special Rules**, below) on or before Turn 25.

The Attacker's success is measured by the number of enemy 'Mech points that are able to exit the north map edge.

VICTORY TABLE		
Defender Victory Points	Attacker Victory Points	Results
Over 30	0	Spectacular Success
24 – 29	1–17	Major Victory
18 – 23	18–23	Mixed Success
17 or less	24 or more	Failure

### Special Rules

This scenario requires a number of quick, lightning thrusts at a larger but predictable enemy. Players need to move the mapsheets to allow battle to continue across a line of march almost three kilometers long.

As the battle moves from south to north, take Map 1 from the south and place it to the north of Map 2 when the first Defender unit crosses the border of Map 2. At this point, Map 1 becomes Map 3. When a Defender unit crosses the northern edge of Map 3, move Map 2 in a similar manner, making it Map 4. This process is repeated until Defender forces cross the border of Map 6 on or before Turn 25.

If Defender units remain on a southern map portion when that map is shifted to the north, consider those units as stragglers who are temporarily lost. Attacker units may reappear on the south edge of the current southern map portion on the third turn after the maps are shifted. Players should make a note with each shift to remind them of when the temporarily lost Attacker units are due to reappear.

The Defender may detach portions of his main force to deal with enemy attacks at any time.

The terrain to the east and west of the entire line of map sheets is covered by woods blocking line-of-sight. The Attacker's 'Mechs may exit the east or west borders of any map at any time. While these 'Mechs are off the map, the Defender may not fire upon them. Three turns after their exiting turn, they may re-enter the same map or the next map to the north from the same direction (east or west) to which they exited. Thus, Carlyle's *Marauder* could exit Map 1 to the east on Turn 3, and reappear anywhere on the east edge of Map 1 or 2 on Turn 6 or later.

The Attacker 'Mechs can fire their weapons only when they are on the map.

'Mechs that receive damage limiting them to 3 MP may exit the map, but may not reappear.

Because of the size of his opponent's force, the Attacker must make quick stabs from different directions, doing as much damage in as short a time as possible, then retreat before the enemy can respond with his overwhelming firepower. The Defender will have to move as quickly as possible toward the north, developing a strategy to screen his main force with some of his 'Mechs to give the main force a chance to reach the north edge of Map 6 in time.

Through brilliant tactics and an almost reckless disregard for the men and machines converging on his position, Carlyle eluded the force detailed to pin down the Gray Death while Kurita reserves poured through the gap in the Steiner perimeter on Baldur. Before the enemy could recover, he launched a series of lightning raids against the Kurita commander's reserves, raids designed to cripple the enemy's fighting effectiveness and to eliminate the threat to the Steiner invasion perimeter.

Captain Nicolo Yamashita, the Kurita reserves commander, was slow to recognize the threat, and slower to respond. Though his force greatly outnumbered the attacker, Yamashita's stubborn adherence to out-of-date orders inhibited his ability to meet and contain the unexpected breakthrough at Ko.

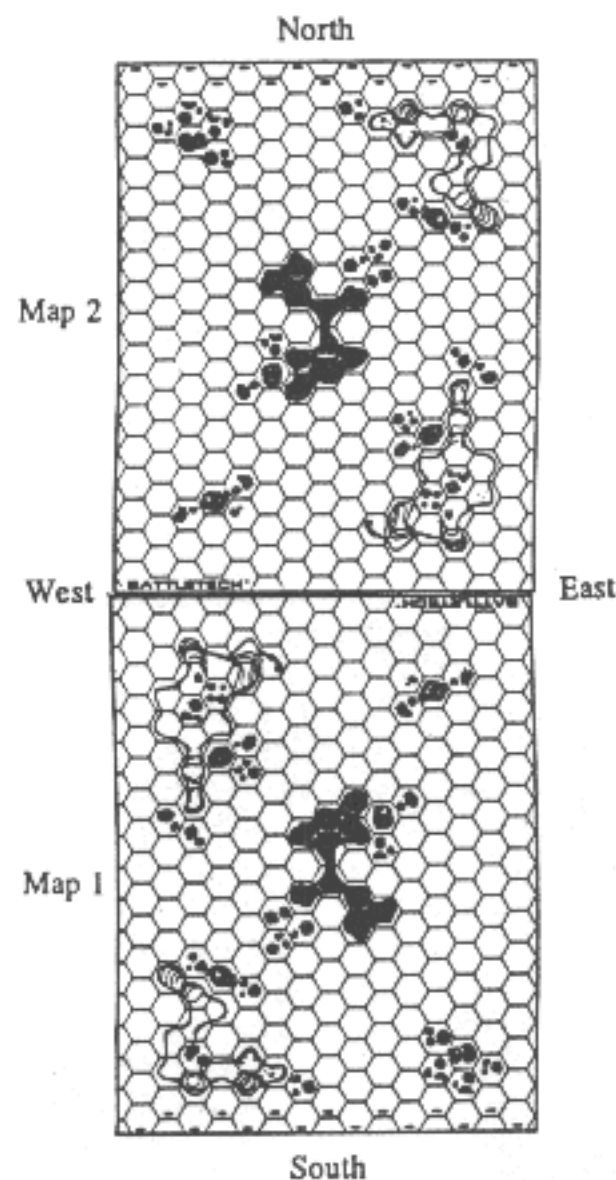

# MEET THE CRIMSON BLADE

## THE ULTIMATE TEST

Excerpted from *'Mechs of Flesh and Blood*, by Lori Kalmar, Avalon Press, 3045.

It's odd, you know, how the fraternity of those who fight and die in combat extends itself across all barriers of clan or rank or government. There is a particularly strong bond among MechWarriors, those of us who pilot small mountains of steel and monofilament across death-blasted deserts at the whim of generals and governments.

After a time, you find you can hate the other fellow. You hate what he stands for, hate his government, hate him because it's his fault you're crouched in a sealed and sweat-stinking metal box eight meters above the ground, waiting for the blast that is going to char you into oblivion. And sometimes you hate an enemy with a name, someone you've tangled with before. That's how it was for poor Isoru and his feud with Takiro Ikeda.

But no matter how much you hate, you find you still respect your opponent, enemy or not. Otherwise, it's because you don't respect yourself, and that's a defeat as final as any suffered on a 'Mech battlefield. That came home to me during the raid on Gram. We'd been in some sharp fights before then, of course. No one could argue that the Gray Death wasn't a top-notch combat team by that time. But at Gram, we had our ultimate test, our confrontation with perhaps the best and most-feared combat 'Mech unit in all the Successor States. At Gram, the Gray Death met the Crimson Blade.



## GAME SET-UP

Lay out the maps as shown, using two map sheets from **BattleTech** and one mapboard from **CityTech**. Players may arrange building counters as desired on and around the paved area on the **CityTech** map.

Prepare record sheets for all 'Mechs engaged in this scenario.

### Defender

The Defender is the Crimson Blade Company of The 5th Sword of Light Regiment.

#### Command Lance

- 1 *Warhammer*
- 1 *Marauder*
- 1 *Crusader* (2 extra Heat Points/turn)
- 1 *Griffin* (3 hex maximum jump, with 2 Heat Points added per hex jumped. PPC misfires and adds heat on 2D6 roll of 10+.)

#### Fire Lance

- 1 *Archer*
- 1 *Archer* (9 Heat Sinks; Left Leg 10 Armor Points)
- 1 *Wasp*
- 1 *Stinger* (maximum 5 MP walking, 8 MP running)

#### Recon Lance

- 1 *Rifleman*
- 1 *Phoenix Hawk* (Left Arm Medium Laser produces 4 Heat Points on a 2D6 roll of 10+)
- 1 *Stinger* (Right Torso carries 4 Armor Points)
- 1 *Stinger*

#### Ground Units

The local defense militia, including any mix desired of Foot and/or Mechanized Infantry and ground or hover armor, totalling no more than 250 tons.

The Defender deploys first anywhere on the map area.



AZIZI AZZARRI "THE CRIMSON BLADE"

## SITUATION: GRAM, 4 JANUARY 3030 (TC)

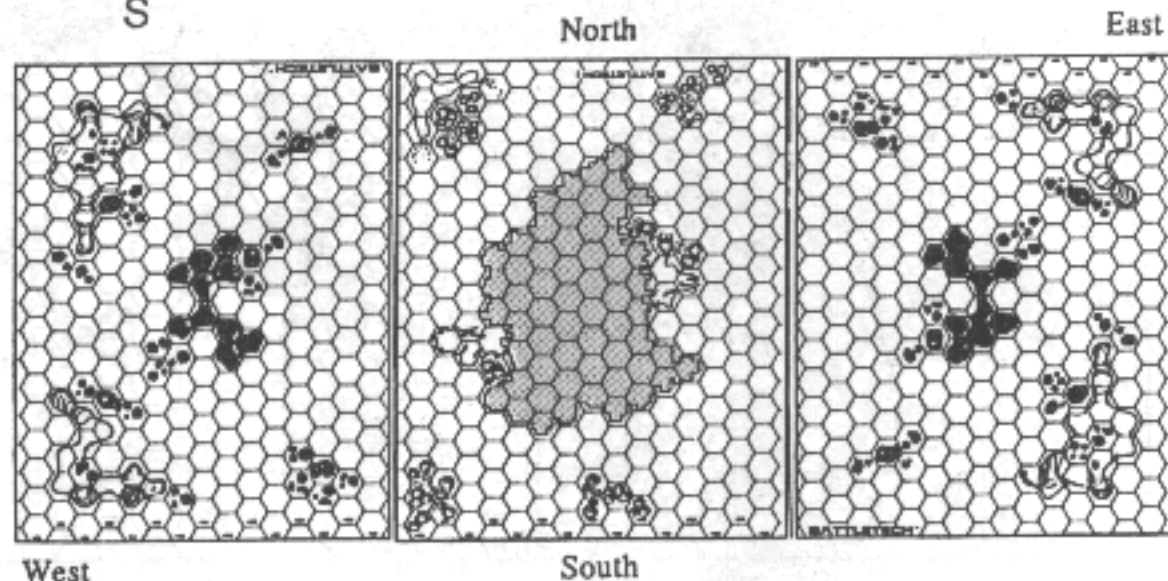
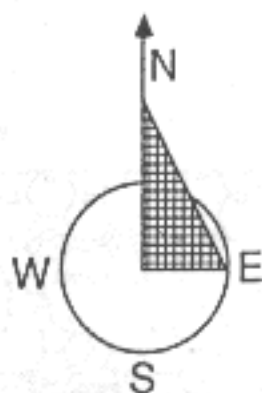
**Attacker**

The Attacker consists of the full Gray Death Mercenary Legion, commanded by Grayson Carlyle, and including all twelve of its 'Mechs, plus ground forces, including any desired mix of Jump, Mechanized, and/or Foot Infantry, and ground or hover vehicles totalling no more than 250 tons. The Attacker enters the map area from the west on Turn 1 or after.

**Victory Conditions**

The Attacker wins by taking the city, with no operating enemy BattleMech left within five hexes of any City hex by Turn 20. The Defender wins by preventing an Attacker victory.

**Special Rules**

This scenario uses all **Expert BattleTech** rules, as well as the rules for **CityTech**.

As described earlier, a blood feud exists between Isoru Koga of the Gray Death's Fire Lance and Nibara Tsukuda of the Crimson Blade. The players may agree that once within range of one another, these two will engage in single 'Mech combat to the exclusion of all else. Either Archer pilot will ignore other orders unless the player giving the order rolls a 9+ on 2D6 at the time.

If the combat breaks off, it will be obvious to all present that another, final confrontation between the two enemies is inevitable.

The raid on Gram was a fairly typical BattleMech hit-and-run raid. Steiner forces had secured temporary superiority in near-Gram space, dropping a regiment of 'Mechs onto a spaceport area near the industrial center of Gram Delta, then landing DropShip troops and equipment to raid the nearby high-tech plants for machine parts, weapons, and 'Mech spares. The operation was notable primarily for the climactic confrontation at the outskirts of the city.

There, an hour after local dawn, advancing elements of the Steiner Strike Force Alpha, including the now full-strength Gray Death Company, encountered a mixed force of defenders that included the infamous Crimson Blade company of the elite 5th Sword of Light Regiment.

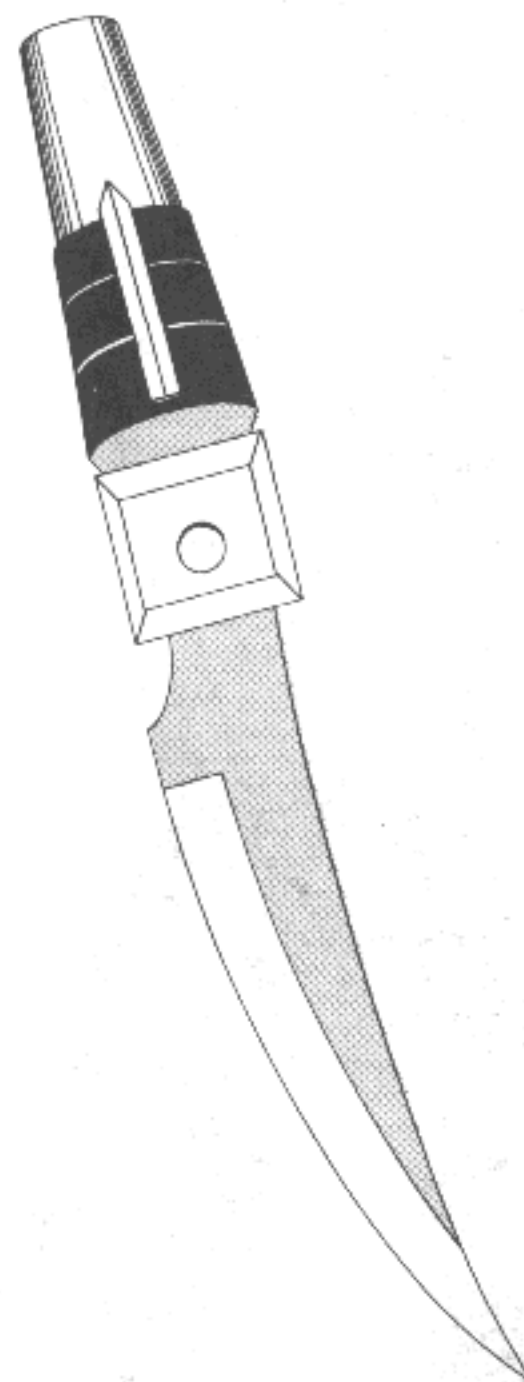

# OF BLOOD AND HONOR

## THE WARRIOR'S WAY

I go to face my enemy, he who dishonored my father and my family. Karma has brought us together here, now, on the field of battle. *Bushido*, the warrior's code by which I live, demands that I face him. The blood of my father cries out for this small vengeance. If I am triumphant, that is karma. If I die, then that is karma, too. Whether I live or die this night makes no difference. What matters only is the blood between us, and the sure fact that one of us will not return to his comrades.

My *Archer* makes an unwieldy *katana*, the honorable sword of the samurai. Yet, my enemy and I are evenly matched, and the contest will be one of skill, courage, and honor.

Remember me to my family in the city of Atarashii Yedo on Kirei na niwa. If I die, tell them it was as a true warrior, as an honorable samurai.

May my family and my name be avenged in blood...

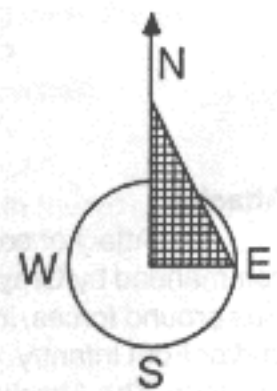
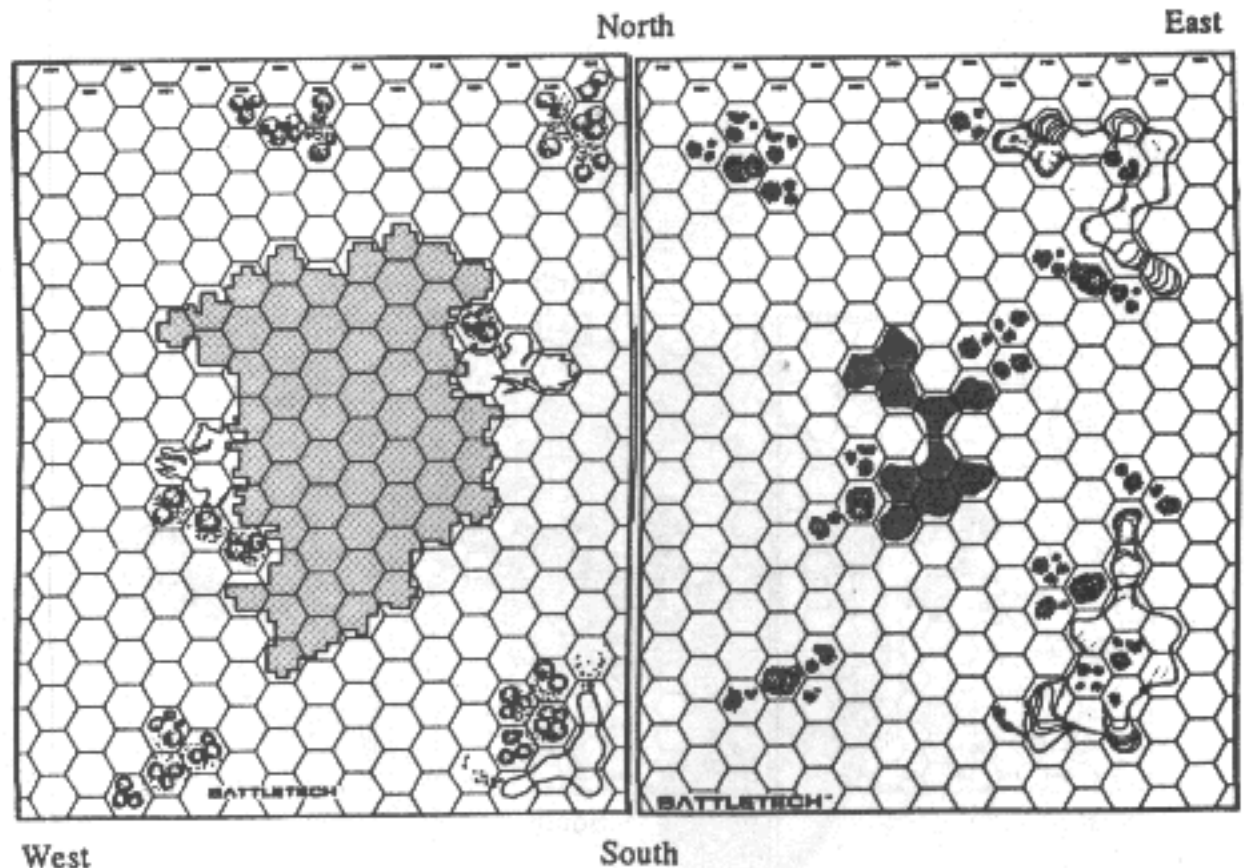
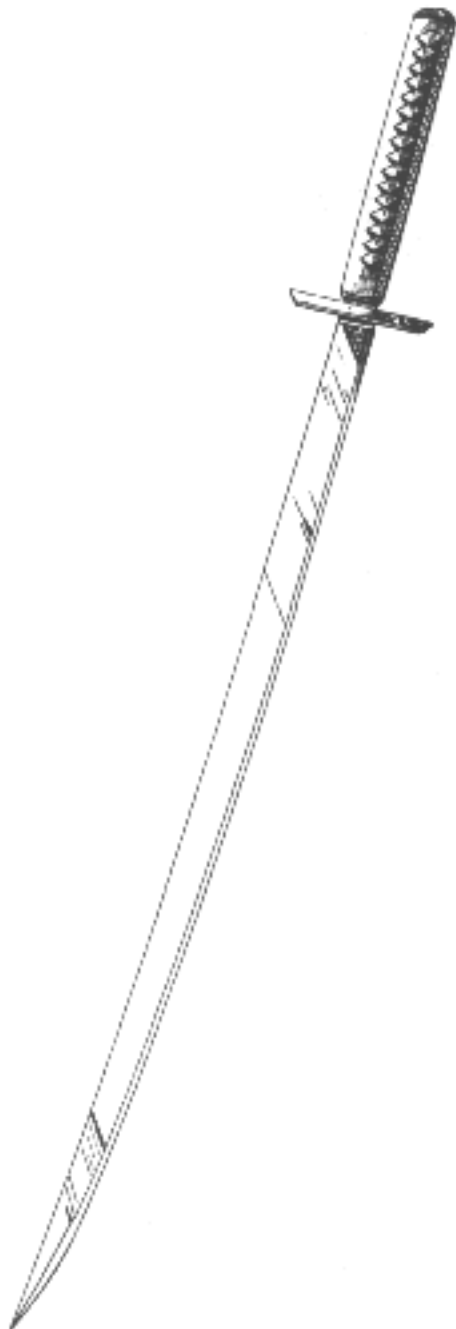

## GAME SET-UP

Lay out one **BattleTech** map and one **CityTech** map as shown. The paved area and the surrounding hexes may be set up with **CityTech** building counters. All Water hexes are considered to be Level 1 hills.

### Tsukuda

Tsukuda's *Archer* is waiting for Koga's 'Mech anywhere on either **BattleTech** map. It will be in full view and not hidden.

### Koga

Koga's *Archer* will enter the battle area from the south.

Both 'Mechs may have sustained damage during the battle of the day before. This damage should be reflected on their 'Mech record sheets. If desired, the players may engage in battle with two undamaged 'Mechs in perfect condition.

## SITUATION: GRAM, 5 JANUARY 3030 (TC)

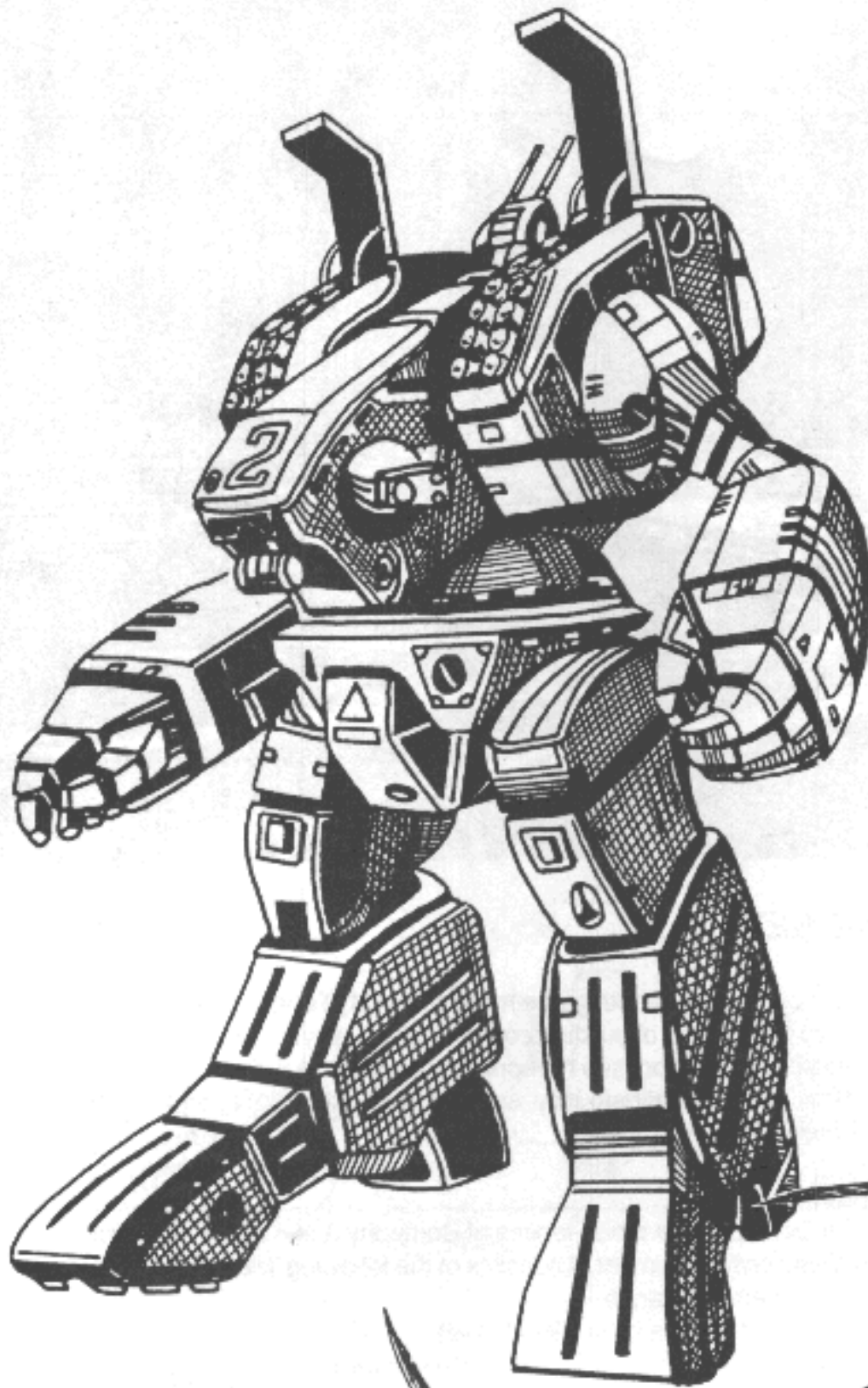

The broad scope of the Succession Wars, the clash and fall of whole empires and the collapse of civilization itself, left plenty of room for the smaller and singularly intense blood debts of hatred or honor that were inevitable between individuals. Many 'MechWarriors were driven by their own, personal vendettas, vowing revenge on enemies who had crossed the boundaries of 'civilized' behavior in war, or who had simply made enemies during the relentless pursuit of their own goals and missions. Grayson Carlyle's vendetta against Hassid Ricol, the Red Duke, is a well-known case in point.

In his diaspora among the stars, man had carried with him the traditions and cultures of a score of Old Earth peoples. Among these traditions, laws, and practices was the ancient code of Bushido, the Warrior's Way, brought to the stars by the warriors of Terra's long-vanished island nation of Nippon and maintained for centuries by their descendants.

MechWarrior Isoru Koga and Lieutenant Nibara Tsukuda are both followers of Bushido. Years ago, on their common homeworld of Kirei na niwa, Ikeda wrongfully accused Koga's father of cowardice in the face of the enemy. The accusation resulted in the disgrace of Koga's family, the loss of his own birthright, and the advancement of Ikeda in the local military hierarchy. It also created a feud between the two that only the death of one or the other will erase, a stain against honor that only blood will cleanse.



**Victory Conditions**  
The survivor wins.

**Special Rules**

This is a fight to the death between two implacable enemies. Combat begins after the two 'Mechs square off at a range of ten hexes or less. Strategy is left to the players. **City Tech** rules for hidden movement within the city should be used.

# NIGHT STRIKE

## ENEMY UNKNOWN

The dark was impenetrable, shrouding friend and enemy alike. The city itself was nothing more than dim, silvery shapes against the stars, a blur of cold blue light on our IR screens. We knew there were people in there. As we drew closer, the flicker of running men or the white-hot exhaust of a ground vehicle could be picked out by their infrared emissions. There could be no doubt. The enemy was there, and he knew we were coming.

What we didn't know was who *he* was. G2 had assured us that Trothas was occupied by local planetary defenses, a handful of aging *Stingers* and *Wasps* piloted by inexperienced militia who scarcely knew how to make their 'Mechs walk. I doubted that, however. It takes an experienced warrior, a cool and battle-hardened 'Mech pilot, to hunker down in a target city and watch the relentless advance of a line of enemy 'Mechs on an IR scope, to watch and wait and hold his fire until assured of a hit. The way I figured it, militia would have been popping missiles at us the moment we stepped into view 400 meters from the city. Here we were now, 60 meters from the nearest buildings, and there was not a sound, not a stir. Either no 'Mechs were in there—which was unlikely—or else we were walking straight into the sights of some of the enemy's best.

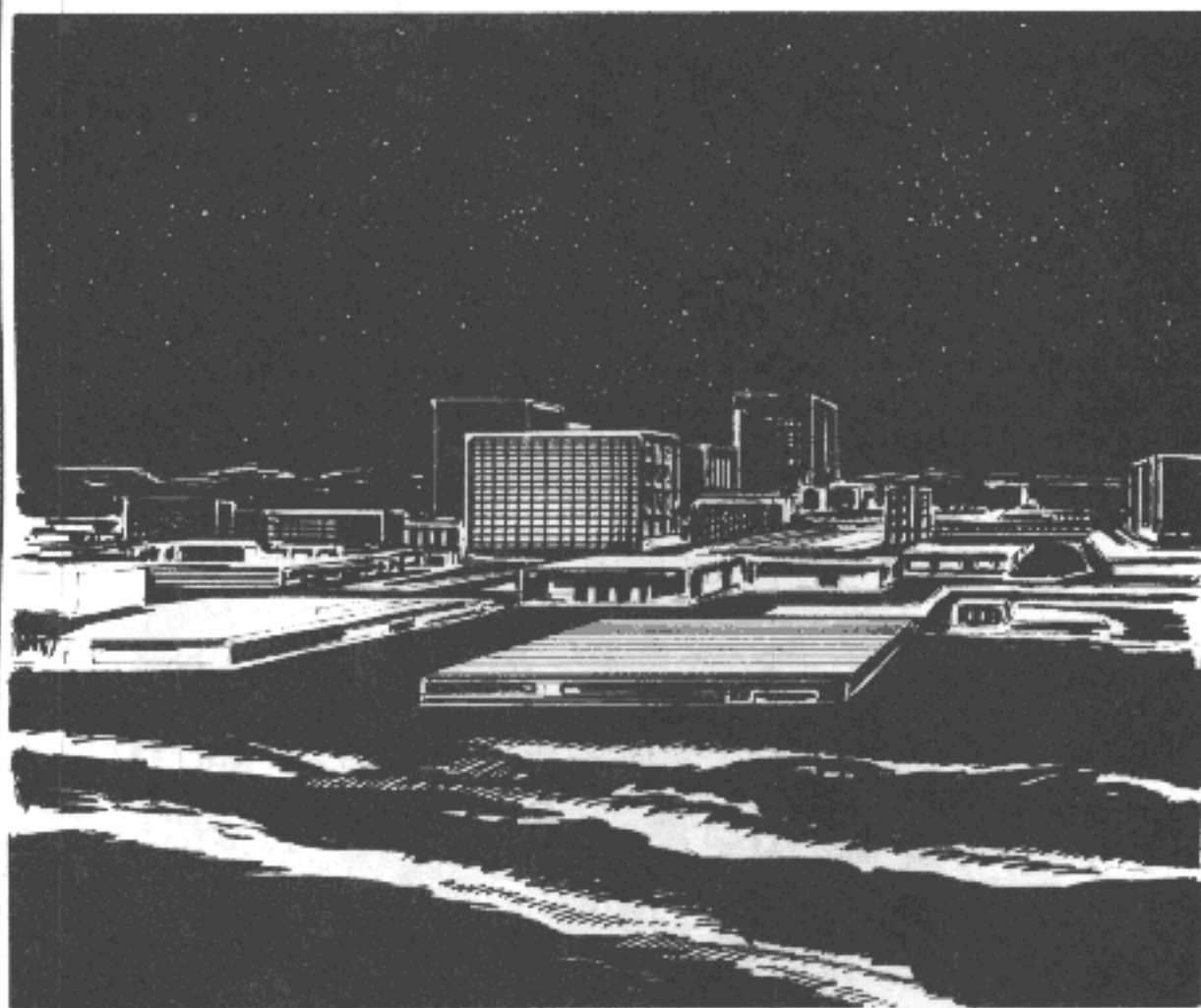
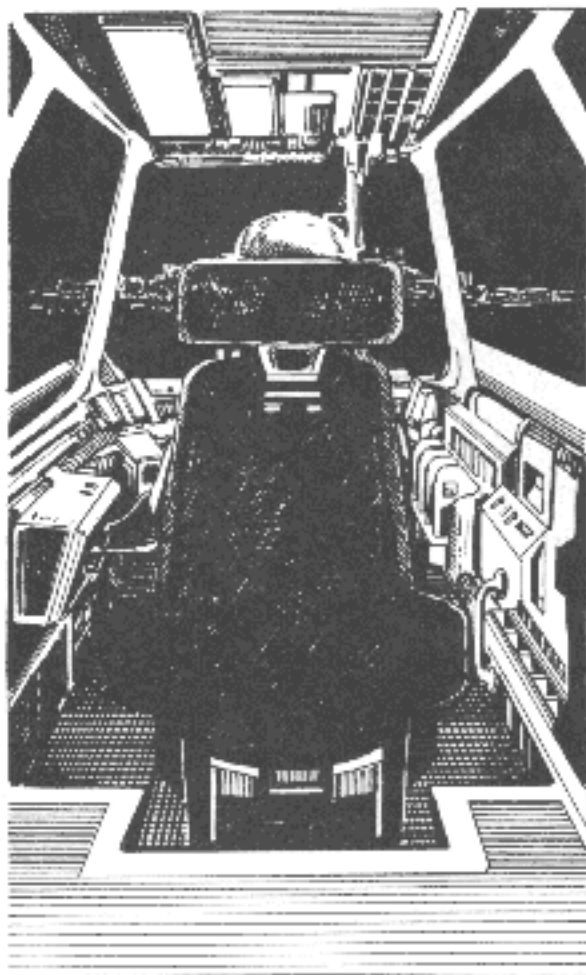

## GAME SET-UP

This scenario uses both game maps from **CityTech**, set up with identical arrangements of building counters. Each player has his own map of the battlefield, and cannot see his opponent's set-up. A third player, acting as a referee, must coordinate play, as described in the **CityTech** rules on limited intelligence.

### Defender

The Defender is two part-lances of Company A of Kurita's 4th Assault Guard "Firestorm" Regiment. It consists of the following 'Mechs:

#### Command Lance

- 1 *Warhammer* (Burkholter)
- 1 *Crusader* (Add 2 Heat Points/turn)
- 1 *Rifleman* (Left Leg 10 Armor Points)
- 1 *Stinger*

#### Fire Lance

- 1 *Marauder* (Friederickson)
- 1 *Archer*
- 1 *Wasp*

The Defender sets up on his map anywhere within the city.

All Defender pilots have MechWarrior skills of *Piloting 3*, *Gunnery 3*.

### Attacker

The Attacker is the Fire and Recon Lances of the Gray Death Legion, as described earlier. The Attacker enters the the battle area on his map anywhere along the east edge of the board.

The Headquarters Lance of the Gray Death is in reserve. It may enter the battle from the east any time *after* Turn 9.

## SITUATION: CITY OF TROTHAS, ON CALDREA, FIVE HOURS BEFORE LOCAL DAWN, 15 MARCH 3030 (TC)

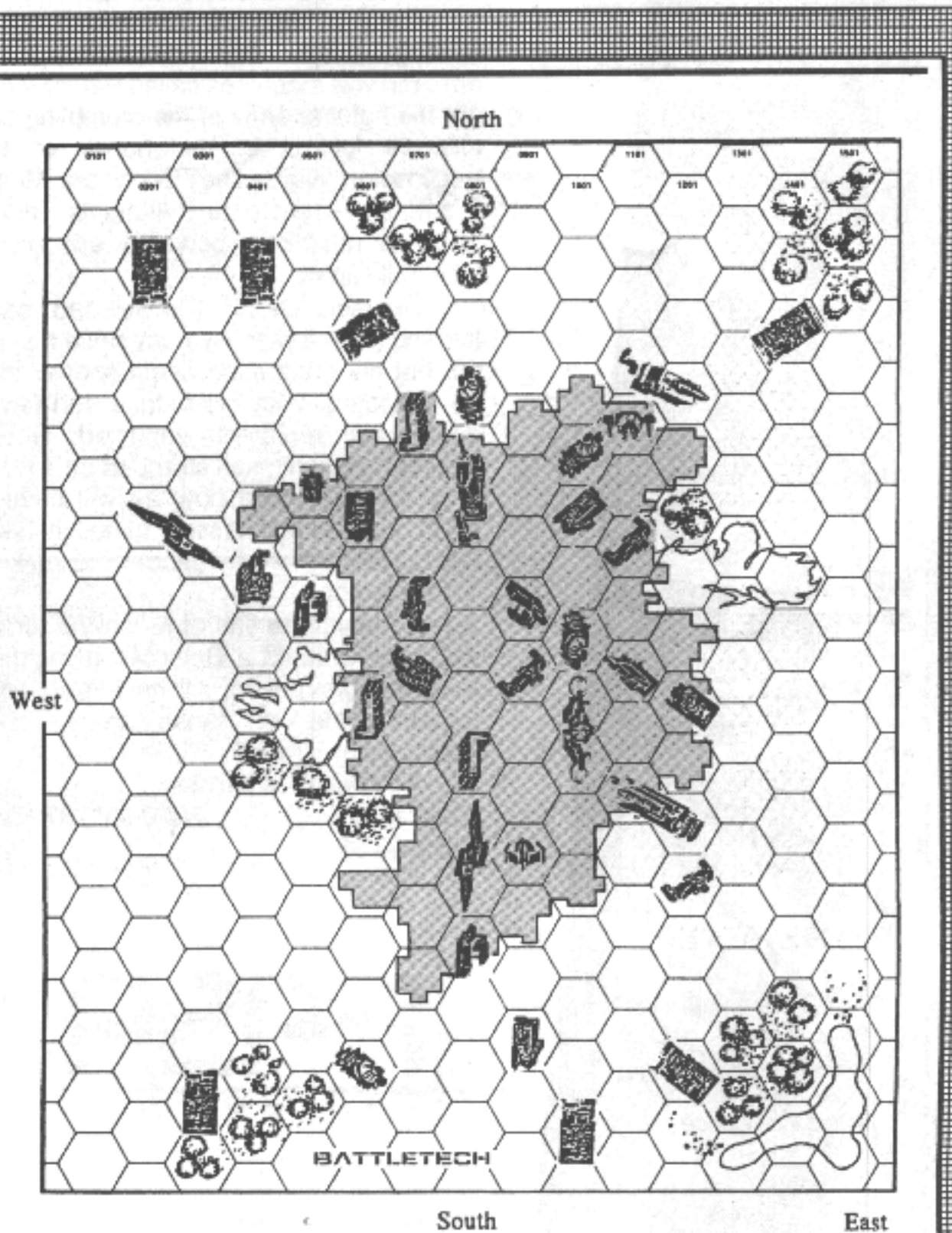

Caldrea was a key world in the Orestes star cluster, site of an important industrial facility and a major Kurita naval base. Control of Caldrea guaranteed control of the Cluster.

Trothas was a small, industrial city on the outskirts of Narve, the Caldrean capital. The Steiner command staff had determined that Trothas was the key to Kurita's defense of Narve and that a swift night strike might give the stalled Caldrean offensive the push it needed to topple the enemy line and to seal a Steiner victory.

The Gray Death was given the mission. With the Headquarters Lance in reserve, the Recon and Fire Lances would enter the town itself, which was believed to hold at least one lance of Caldrean militia. Once secured, Trothas would become the jump-off point for the 1st Lyran Guards in their assault on Narve.

What no one knew was that Lyran G2 intelligence was wrong. The force that awaited the Steiner assault on Trothas was not made up of militia.

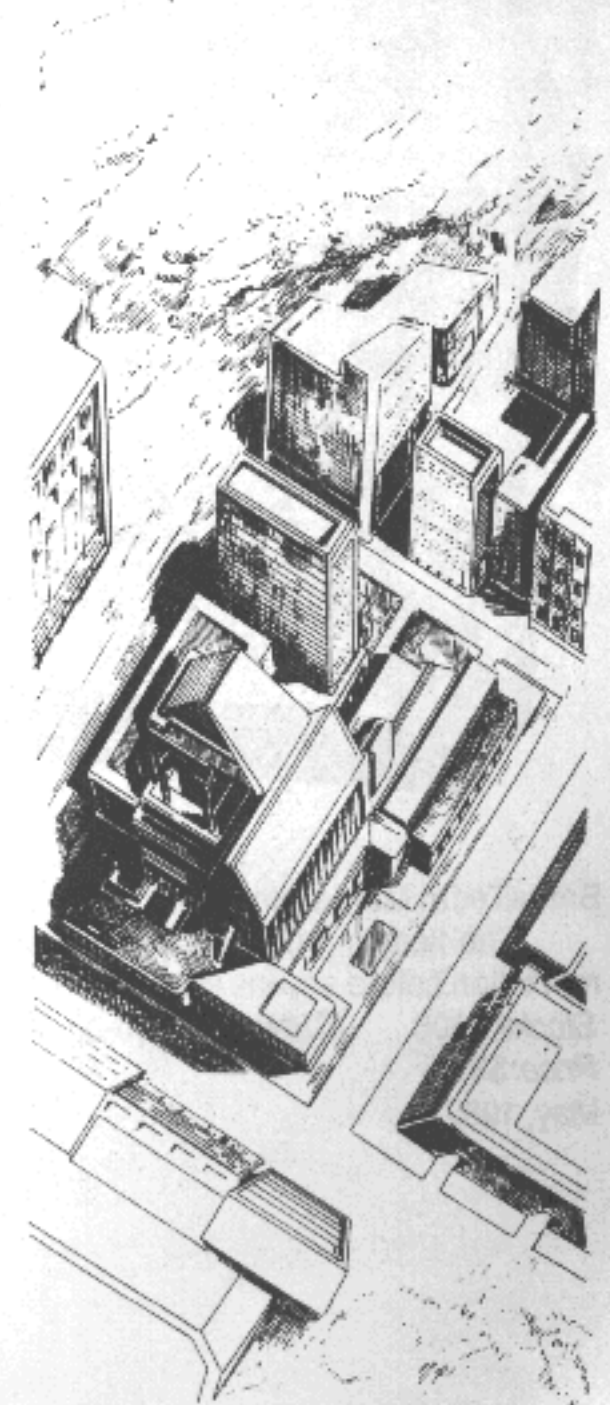

### Victory Conditions

The side that controls the city, with no combat-capable enemy 'Mechs on any paved hex by Turn 25, wins. If both sides have 'Mechs capable of combat within the city after Turn 25, the battle is a draw.

### Special Rules

The Battle of Trothas takes place at night. 'Mechs can detect one another using radar and IR scanners, but weapon accuracy is adversely affected. There is an automatic +2 on all Base To-Hit Numbers.

The *Warhammers* piloted by Khaled and Burkholter are equipped with powerful searchlights for night combat. Players may employ these or not, at their own discretion. When a *Warhammer's* searchlight is on, eliminate the +2 die modifier on Base To-Hit Numbers against any target in the 'Mech's forward firing arc. Combat is otherwise carried out normally. Any hit against a *Warhammer's* head, central torso, or back will destroy the searchlight on a separate 2D6 roll of 7+.



# Read the adventures of the **GRAY DEATH LEGION**

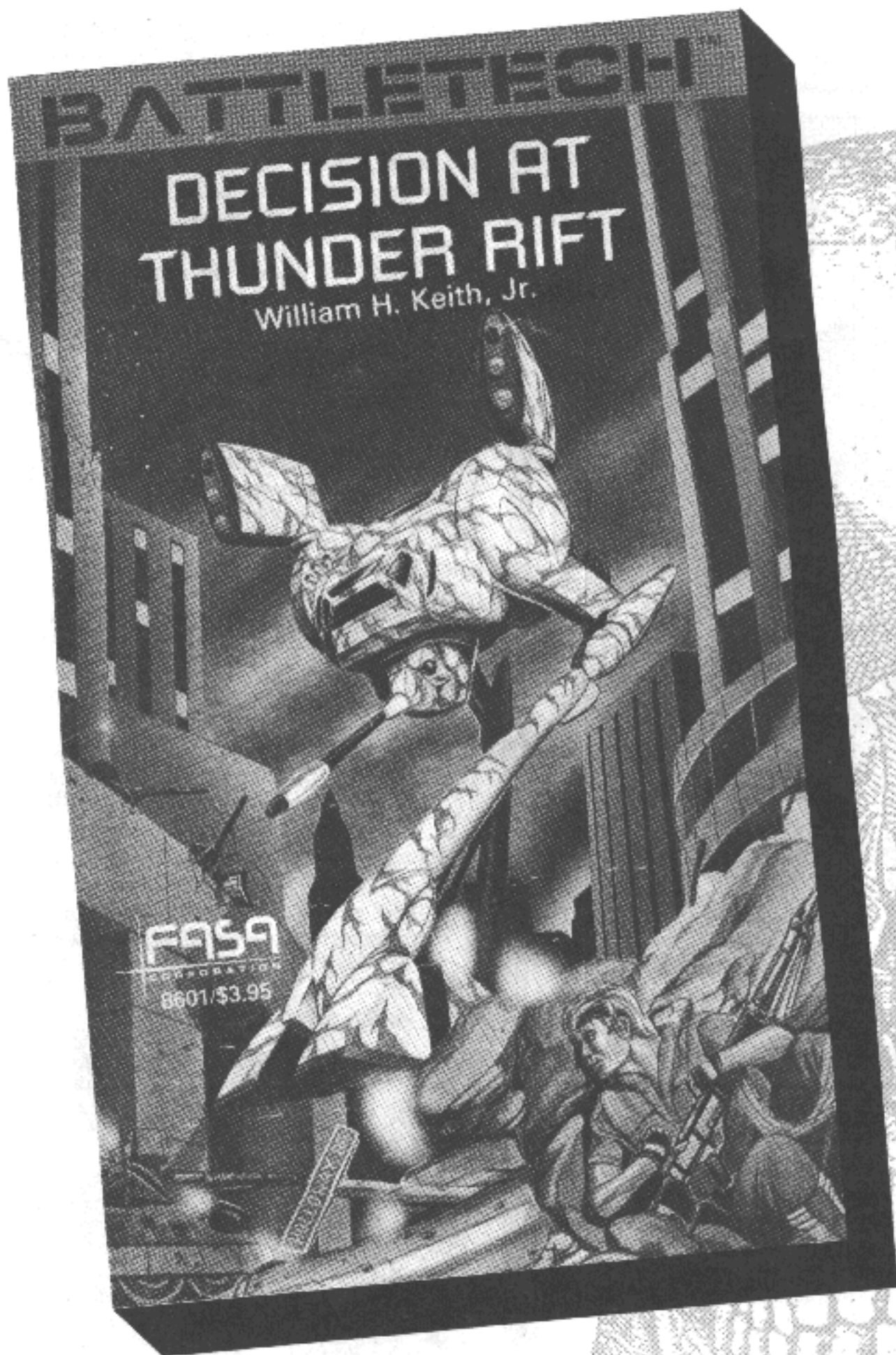

## BattleTech: Decision At Thunder Rift

Thirty meters tall, 70 tons of quick-striding death and destruction, the armored war machines called BattleMechs are the fighting arms of the crumbling star empires locked in the horror of the Succession Wars. Their pilots are MechWarriors, 31st-Century knights riding armored machines powerful enough to take a city apart.

Grayson Death Carlyle had been training to be a MechWarrior since he was 10, but his graduation came sooner than he expected. With his friends and family dead, his regiment vanished, young Grayson finds himself stranded on a world turned hostile. And now he will have to learn the hardest lesson of all: it takes more than armored weaponry to make a MechWarrior.

To claim the title of MechWarrior, he will have to build a BattleMech regiment from the ground up. All he has to do is capture one of those giant killing machines by himself.

If it doesn't kill him first.

Stock #8601

ISBN #0-931787-69-6

Price: \$3.95

**FASA**  
CORPORATION

FASA Corporation  
P.O. Box 6930  
Chicago, IL 60680

## BattleTech: Mercenary's Star

The fledgling Gray Death Legion organizes as a BattleMech mercenary band, but learn that they have to earn their reputation before anyone will hire them. Their only opportunity is fighting for a rebellion that has already been crushed!

Stock#8606 ISBN#1-55560-030-1

Price: \$3.95

May, 1987

# THE SAGA OF THE GRAY DEATH LEGION

## BATTLETECH

BATTLETECH is a trademark of FASA Corporation registered in the U.S. Patent and Trademark Office.  
Copyright © 1986 FASA Corporation.  
All Rights Reserved. Printed in the United States of America.

### Command Lance

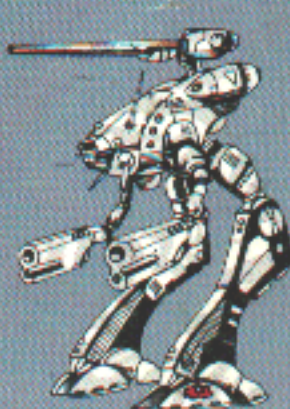

**Marauder**  
Col. Carlyle



**Shadow Hawk**  
Kalmar



**Wolverine**  
Sgt. Clay



**Rifleman**  
McCall

### Fire Lance

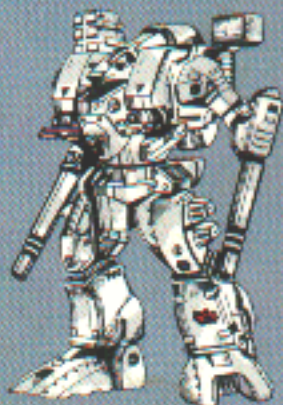

**Warhammer**  
Lt. Kahled



**Archer**  
Koga

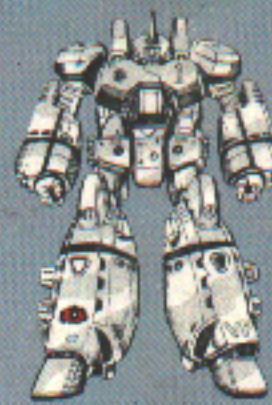

**Crusader**  
Bear

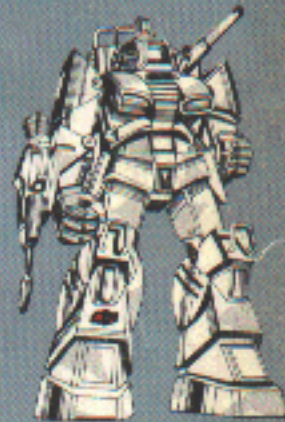

**Shadow Hawk**  
Sharyl

### Recon Lance



**Griffin**  
Lt. Cristobal DeVillar



**Phoenix Hawk**  
Kent



**Stinger**  
Blake



**Stinger**  
Sharpley



Treachery and betrayal gave birth to the Gray Death mercenary regiment, one of the most feared and respected units of the Succession Wars. It was his father's death at the hands of traitors on the Periphery world of Trelwan that forced young Grayson Carlyle to create a 'Mech unit from next to nothing and to face off with the Red Duke, one of Kurita's minions. From then on, Carlyle and his men struggled long and hard to win respect as a mercenary unit in the Inner Sphere.

The **Gray Death Legion** scenario set describes major battles fought by the unit, as told in the novels **Decision at Thunder Rift**, **Mercenary's Star**, and **The Price of Glory**. You will follow the Legion's rise from a mere three 'Mechs to a full combined arms regiment feared and admired by both enemies and friends. The set also provides the statistics and condition of the Gray Death Companions (Carlyle's personal company and bodyguard) and the conditions of their 'Mechs. Also included are 15 scenarios of some of the more notable battles fought by the Legion.

Some of the scenarios included are:

- Decision at Thunder Rift**
- Thirst for Vengeance**
- Betrayal at Helm (4 scenario campaign)**
- Breakout at Ko**
- Of Blood and Honor**



34057 01617

ISBN1-55560-026-3 FASA800